

INTERNATIONAL CHEMISTRY OLYMPIADS

1986 - 1994

Solutions

edited by Marco Ziegler

Triple Medallist ICHO 1990, 1991, 1992

University of Fribourg, Switzerland

1993

©by Marco Ziegler

This version is free of charge and may be distributed freely. Comments, corrections and other interesting problems that will be incorporated in a larger problem compilation should be sent to Marco.Ziegler@Unifr.ch

1. Analytical chemistry

IChO Veszprém - Budapest 1987

- a) β_2 indicates that the complexation of Ag^+ with CN^- easily occurs. Thus A denotes the point where all Ag^+ is present in complex form, having a higher potential than Ag^+ , B shows the point where the precipitation of AgCN starts thus leading to a constant Ag^+ concentration until all CN^- is precipitated. Now at point C the precipitation of the more soluble AgCl begins:

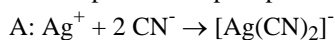

b) $2 \cdot 2.47 \text{ ml} = \underline{4.94 \text{ ml}}$

c) $[\text{CN}^-] = (4.94 \cdot 0.1 \cdot 40) / 1000 \text{ mol/l} = 1.98 \cdot 10^{-2} \text{ mol/l}$
 $[\text{Cl}^-] = ((10 - 4.94) \cdot 0.1 \cdot 40) / 1000 \text{ mol/l} = 2.02 \cdot 10^{-2} \text{ mol/l}$

d) For the system Ag/Ag^+ at point A: $E = E_0 + 0.059 \log[\text{Ag}^+]$

The following equations are derived from the equilibrium conditions:

$$[\text{Ag}^+] = \frac{[\text{Ag}(\text{CN})_2^-]}{[\text{CN}^-]^2 \beta_2} \quad \text{with} \quad [\text{Ag}^+] + [\text{Ag}(\text{CN})_2^-] = \frac{2.47 \cdot 0.1}{25 + 2.47} \text{ mol/l}; \quad [\text{CN}^-] = 2 \cdot [\text{Ag}^+]$$

which yields an equation of third degree in $[\text{Ag}^+]$:

$$4\beta_2[\text{Ag}^+]^3 + [\text{Ag}(\text{CN})_2^-] = 0$$

$[\text{Ag}(\text{CN})_2^-]$ can be assumed to be $(2.47 \cdot 0.1) / 27.46 \text{ mol/l}$ and therefore $[\text{Ag}^+]$ equals $1.213 \cdot 10^{-8} \text{ mol/l}$.

The emf will be: $E = 0.8 + 0.059 \log[\text{Ag}^+] - 0.285 = \underline{0.048 \text{ V}}$

at point C: $[\text{Ag}^+] = \sqrt{K_{\text{sp}}(\text{AgCl})} = 1.333 \cdot 10^{-5} \text{ mol/l}$ and $E = 0.8 + 0.059 \log[\text{Ag}^+] - 0.285 = \underline{0.227 \text{ V}}$

- e) Since both AgCN and AgCl are present in the precipitate, the solution must be saturated:

in the solution: $[\text{Cl}^-]/[\text{CN}^-] = K_{\text{sp}}(\text{AgCl})/K_{\text{sp}}(\text{AgCN}) = 10^{6.05} = \underline{1.222 \cdot 10^6}$
 in the precipitate: $n[\text{AgCl}]/n[\text{AgCN}] = 2.02/1.98 = \underline{1.02}$

IChO Helsinki 1988

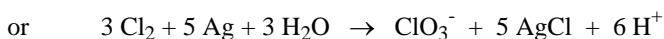
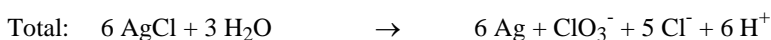

b) Of 100 g AgCl 12 g decompose and 88 g remain. 12 g equals 0.0837 mol and therefore 0.04185 mol Cl₂ are liberated. Out of that (12·107.9)/143.3 = 9.03 g Ag remain is the precipitate. 5/6·0.837 mol AgCl are newly formed (= 10.0 g), so that the total mass of precipitate (A) yields:

$$A = 88 \text{ g} + 9.03 \text{ g} + 10.0 \text{ g} = \underline{107.03 \text{ g}}; \text{ relative error} = \underline{7.03 \%}$$

c) $[H^+] = [A^-] + [L^-] + [OH^-]$

$$[HA] + [A^-] = 0.02 \text{ mol/l} \quad pK(HA) = pH + p[A^-] - p[HA] = 4 \quad (\Rightarrow \text{graph})$$

$$[HL] + [L^-] = 0.01 \text{ mol/l} \quad pK(HL) = pH + p[L^-] - p[HL] = 7 \quad (\Rightarrow \text{graph})$$

For problems like these, where no formal algebraic solution is found, only simplifications lead to a good approximation of the desired result, e.g

1. $[H^+] = [A^-]$ (since HA is a much stronger acid than HL such that $[H^+], [A^-] \gg [L^-], [OH^-]$)

$$[H^+]^2 + K_{(HA)}[H^+] - K_{(HA)}0.02 = 0 \Rightarrow [H^+] = 1.365 \cdot 10^{-3} \text{ mol/l}; \text{ pH} = \underline{2.865}$$

2. Linear combination of the equations

$$[H^+] = K_{(HA)} \cdot [HA] / [A^-] = K_{(HL)} \cdot [HL] / [L^-]$$

$$[HA] = 0.02 - [A^-]; [HL] = 0.01 - [L^-]; [H^+] = [A^-] + [L^-] + [OH^-]$$

yields:

$$[A^-] = \frac{0.02 \cdot K_{(HA)}}{[H^+] + K_{(HA)}}$$

$$[L^-] = \frac{0.01 \cdot K_{(HL)}}{[H^+] + K_{(HL)}}$$

$$[H^+] = \frac{0.02 \cdot K_{(HA)}}{[H^+] + K_{(HA)}} + \frac{0.01 \cdot K_{(HL)}}{[H^+] + K_{(HL)}} + \frac{K_W}{[H^+]}$$

The equation above can only be solved by numerical approximation methods. The result is pH = 2.865. We see that it's not necessary to consider all equations. Simplifications can be made here without loss of accuracy. Obviously it's quite difficult to see the effects of a simplification - but being aware of the fact that already the so-called exact solution is not really an exact one (e.g. activities are not being considered), simple assumption often lead to a very accurate result.

$$K_1' = \frac{[ML]}{[M]([L] + [HL] + [NHL] + [H_2L])} = \frac{K_1[L]}{([L] + [HL] + [NHL] + [H_2L])}$$

$$[HL] = \frac{K_{a1}[H_2L]}{[H]}; [HL] = \frac{L \cdot H}{K_{a2}}; [L] = \frac{K_{a2} \cdot [HL]}{[H]} = \frac{K_{a1} \cdot K_{a2} \cdot [H_2L]}{[H]^2};$$

$$[NHL] = K_{NHL} [N][L][H]$$

And finally

$$\Rightarrow K_1' = \frac{K_1}{\left[1 + \frac{[H]}{K_{a1}} + \frac{[H]^2}{K_{a1}K_{a2}} + K_{NHL} [N][H]\right]}$$

IChO Pittsburgh 1992

- a) $[\text{Cl}^-] = (0.01616 \text{ l}) (0.00164 \text{ M}) / (0.05 \text{ l}) = 5.30 \cdot 10^{-4} \text{ M} \equiv 18.8 \text{ mg/l}$
Thus the chloride concentration is sufficiently high for normal oyster growth.
- b) $\text{Ag}^+ (\text{aq}) + \text{Cl}^- (\text{aq}) \rightarrow \text{AgCl} \downarrow (\text{s})$
- c) $2 \text{Ag}^+ (\text{aq}) + \text{CrO}_4^{2-} (\text{aq}) \rightarrow \text{Ag}_2\text{CrO}_4 \downarrow (\text{s})$
- d) $K_{\text{sp}}(\text{Ag}_2\text{CrO}_4) = [\text{Ag}^+]^2 [\text{CrO}_4^{2-}] = 4x^3$ if $x = [\text{Ag}^+] \Rightarrow [\text{Ag}^+] = 7.07 \cdot 10^{-6}$; $[\text{CrO}_4^{2-}] = 2 \cdot 10^{-2}$
 $[\text{Cl}^-] = K_{\text{sp}}(\text{AgCl}) / [\text{Ag}^+] = 1.78 \cdot 10^{-10} / 7.07 \cdot 10^{-6} = 2.5 \cdot 10^{-5} \text{ M}$
- e) $2 \text{CrO}_4^{2-} + 2 \text{H}^+ \rightleftharpoons \text{Cr}_2\text{O}_7^{2-} + \text{H}_2\text{O}$ either/or $\text{CrO}_4^{2-} + \text{H}^+ \rightleftharpoons \text{HCrO}_4^- + \text{H}_2\text{O}$
- f) A buffer system has its maximum buffer capacity when $\text{pH} = \text{pK}_a$. So, the system 3 would be best since $\text{pK}_a = 7.2$
- g) $(0.1 \text{ mol/l}) (0.5 \text{ l}) (119.98 \text{ g/mol}) = 6.0 \text{ g NaH}_2\text{PO}_4$
 $(0.1 \text{ mol/l}) (0.5 \text{ l}) (141.96 \text{ g/mol}) = 7.1 \text{ g Na}_2\text{HPO}_4$
- h) mol Ag^+ added: $n(\text{Ag}^+)_{\text{ad}} = (0.05 \text{ l}) (0.00129 \text{ mol/l}) = 6.45 \cdot 10^{-5} \text{ mol}$
mol Ag^+ left: $n(\text{Ag}^+)_{\text{left}} = (0.02746 \text{ l}) (1.41 \cdot 10^{-3} \text{ mol/l}) = 3.87 \cdot 10^{-5} \text{ mol}$
mol Cl^- in sample: $n(\text{Cl}^-) = n(\text{Ag}^+)_{\text{ad}} - n(\text{Ag}^+)_{\text{left}} = (6.45 \cdot 10^{-5} \text{ mol}) - (3.87 \cdot 10^{-5} \text{ mol}) = 2.58 \cdot 10^{-5} \text{ mol}$
 $\Rightarrow [\text{Cl}^-] = 2.58 \cdot 10^{-5} / 0.05 = 5.16 \cdot 10^{-4} \text{ mol/l}$
- i) mol AgCl lost: $(0.010 \text{ g AgCl}) / (143.35 \text{ g/mol}) = 6.98 \cdot 10^{-5} \text{ mol}$
mol Cl_2 produced $\frac{1}{2}(6.98 \cdot 10^{-5}) = 3.49 \cdot 10^{-5} \text{ mol}$
mol new AgCl prod. $5/3 (3.49 \cdot 10^{-5}) = 5.82 \cdot 10^{-5} \text{ mol} \equiv 8.34 \text{ mg}$
The amount of Ag formed is equal to the amount of AgCl lost, thus $[\text{Ag}]_{\text{formed}} = (6.98 \cdot 10^{-5} \text{ mol}) (107.9 \text{ g/mol}) = 7.53 \text{ mg}$
The mass of the sample is equal to $3.0 \text{ g} - 0.01 \text{ g} + 8.34 \text{ mg} + 7.53 \text{ mg} = 3.006 \text{ g}$. Therefore the total mass of the solid will be too high and the difference is 5.87 mg.

IChO Perugia 93

- a) Baseline separation requires that $R \geq 1.5$ for each pair of peaks (GCA/CA , $\text{i.s.}/\text{GCA}$). N can be calculated from the N/m value taking into account that the column length is 25 cm:

$$N = 2.56 \cdot 10^4 (25/100) = 64 \cdot 10^2$$

By substituting the α , K and N values in the above equation, the resolution for each pair of peaks is found as follows:

For column A:

$$\alpha_{\text{GCA}/\text{CA}} = (399-120)/(380-120) = 279/260 = 1.07$$

$$K'_{\text{GCA}} = (399-120)/120 = 2.32$$

$$R_{\text{GCA}/\text{CA}} = (\sqrt{6400}/4) (0.07/1.07) (2.32/3.32) = 0.91$$

$$\alpha_{\text{i.s.}/\text{CA}} = (442-120)/(399-120) = 222/279 = 1.15$$

$$K'_{\text{i.s.}} = (442-120)/120 = 2.68$$

$$R_{\text{i.s.}/\text{CA}} = (\sqrt{6400}/4) (0.15/1.15) (2.68/3.68) = 1.90$$

For column B

$$\alpha_{\text{GCA/CA}} = (395-130)/(350-130) = 265/260 = 1.20$$

$$K'_{\text{GCA}} = (395-130)/130 = 2.04$$

$$R_{\text{GCA/CA}} = (\sqrt{6400}/4) (0.20/1.20) (2.04/3.04) = 2.2$$

$$\alpha_{\text{i.s./CA}} = (430-130)/(395-130) = 300/265 = 1.13$$

$$K'_{\text{i.s.}} = (430-130)/130 = 2.31$$

$$R_{\text{i.s./CA}} = (\sqrt{6400}/4) (0.13/1.13) (2.31/3.31) = 1.6$$

For column B the minimum value for R is 1.6 so that complete separation is obtained where for column A, $R=0.91$. Therefore, column B should be used.

b) The amount of acid in the extract solution (1 mL) can be calculated from the relationship:

$$\mu\text{moles}_{\text{acid}}/\mu\text{moles}_{\text{i.s.}} = (\text{Area}_{\text{acid}}/\text{Area}_{\text{i.s.}})/F \text{ where } F \text{ is the response factor.}$$

Therefore:

$$\mu\text{moles}_{\text{acid}} = (\text{Area}_{\text{acid}}/\text{Area}_{\text{i.s.}})/F \mu\text{moles}_{\text{i.s.}}$$

$$\text{CA} = [(2200/2304)/0.5] 2.7 \cdot 10 = 51.6 \mu\text{moles}$$

$$\text{GCA} = [(3520/2304)/0.2] 2.7 \cdot 10 = 206 \mu\text{moles}$$

2. Inorganic chemistry

IChO Leiden 1986

a-c) The isomers are:

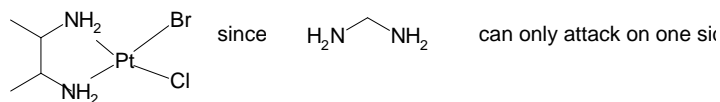
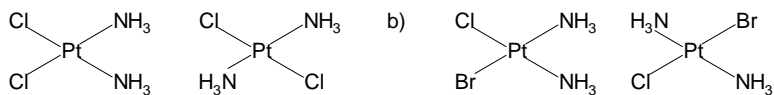

d) The following 9 isomers are possible:

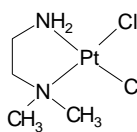

I1

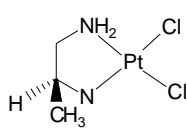

I2

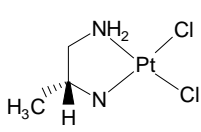

I3

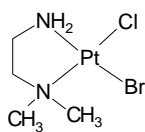

I4

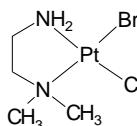

I5

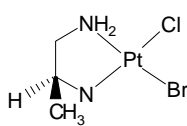

I6

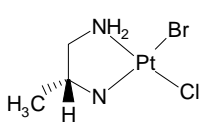

I7

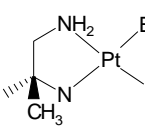

I8

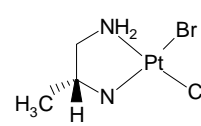

I9

e) In a-c) there is no change possible in d) I4 and I5, I6 and I7, I8 and I9 transform into one other. Through this isomerisation also $\text{PtCl}_2(\text{dmen})$, $\text{PtBr}_2(\text{dmen})$, $\text{PtCl}_2(\text{pn})$ and $\text{PtBr}_2(\text{pn})$ can be formed, even though they are not isomers.

f) $\text{PtCl}_2(\text{en}) : \text{PtBr}_2(\text{en}) : \text{PtBrCl}(\text{en}) = 1 : 1 : 2$

g)

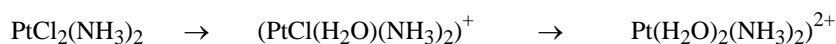

In blood the hydrolysis does not occur, because the concentration of Cl^- is rather high and the equilibrium on the left side.

h) The bond is due to the cis-isomer, because in that case the distance between the bases (320 pm) has to change only $210 \cdot \sqrt{2} = 297$ nm, whereas the trans-compound would have a distant of $210 \cdot 2 = 420$ nm.

IChO Leiden 1986

a) The structures are:

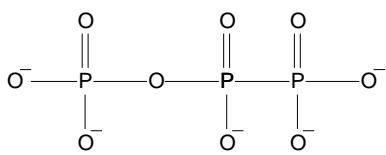
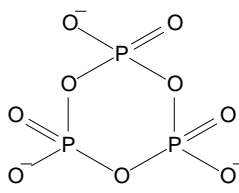
 $\text{P}_3\text{O}_{10}^{5-}$  $[\text{P}_3\text{O}_6]^{3-}$

b) Since Mg^{2+} has the coordination number 6 one water molecule serves as the sixth ligand among the five O^- ligands already present in the $[\text{P}_3\text{O}_{10}]^{5-}$ - ligand:

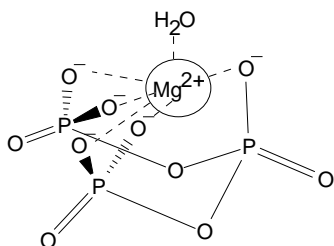

- c) Possible ions are Al^{3+} or Fe^{2+} because of their equal charge and similar size. The triphosphates are not soluble in water.
- d) $[\text{Ca}^{2+}] + [\text{CaP}_3\text{O}_{10}]^{3-} = 0.225/40 \text{ mol/l}$; $[\text{Ca}^{2+}] = 0.02/40 \text{ mol/l} \Rightarrow [\text{CaP}_3\text{O}_{10}]^{3-} = 0.205/40 \text{ mol/l}$
 $[\text{P}_3\text{O}_{10}^{5-}] = K_1[\text{CaP}_3\text{O}_{10}]^{3-} / [\text{Ca}^{2+}] = 1.025 \cdot 10^{-5} \text{ mol/l}$
 $[\text{CaP}_3\text{O}_{10}]^{3-} + [\text{P}_3\text{O}_{10}^{5-}] = 5.135 \cdot 10^{-3} \text{ mol/l} \approx \underline{37.6 \text{ g Na}_3\text{P}_3\text{O}_{10} \text{ in } 20 \text{ l H}_2\text{O}}$

IChO Veszprém - Budapest 1987

- a) $[\text{H}_3\text{PO}_4] + [\text{HPO}_4^{2-}] + [\text{H}_2\text{PO}_4^-] + [\text{PO}_4^{3-}] = T_{\text{konst}}$; $[\text{H}^+] = 10^{-10} \text{ mol/l}$
 $[\text{H}_3\text{PO}_4] = 1 \text{ mol/l}$
 $[\text{PO}_4^{3-}] = (K_3[\text{H}^+]^3)^{-1} = 2.5 \cdot 10^9 \text{ mol/l} = 1.955\%$
 $[\text{HPO}_4^{2-}] = K_1[\text{PO}_4^{3-}][\text{H}^+] = 1.25 \cdot 10^{10} \text{ mol/l} = 97.97\%$
 $[\text{H}_2\text{PO}_4^-] = K_2[\text{PO}_4^{3-}][\text{H}^+]^2 = 1 \cdot 10^8 \text{ mol/l} = 0.078\%$
- b) $\text{Na}_{3-n}(\text{H}_n\text{PO}_4) \cdot m \cdot \text{H}_2\text{O}$ ($n = 0, 1, 2$)

The titrated solution contains 100 mg (y mole) of the salt and 1.00 mmol of sulphuric acid. The reacted protons (in mmol) can be calculated using the results of a): $2 + (n - 0.9797 - 2 \cdot 0.00078)y = 2.653$

Since $y = 100/M$ (in mmol) but $M \geq 120 \text{ g/mol}$ the only real solution is $n = 2$. Therefore $M = 156 \text{ g/mol}$, m is $(156 - 120)/18 = 2 \Rightarrow \underline{\text{NaH}_2\text{PO}_4 \cdot 2\text{H}_2\text{O}}$

IChO Helsinki 1988

- a) Fig. 12 shows the electron densities. The electronic configuration of the element A is $1s^2 2s^2 3s^2 3p^6 3d^{10} 4s^2 4p^6 4d^{10} 5s^2 5p^6$ which is an inert gas (Xe).

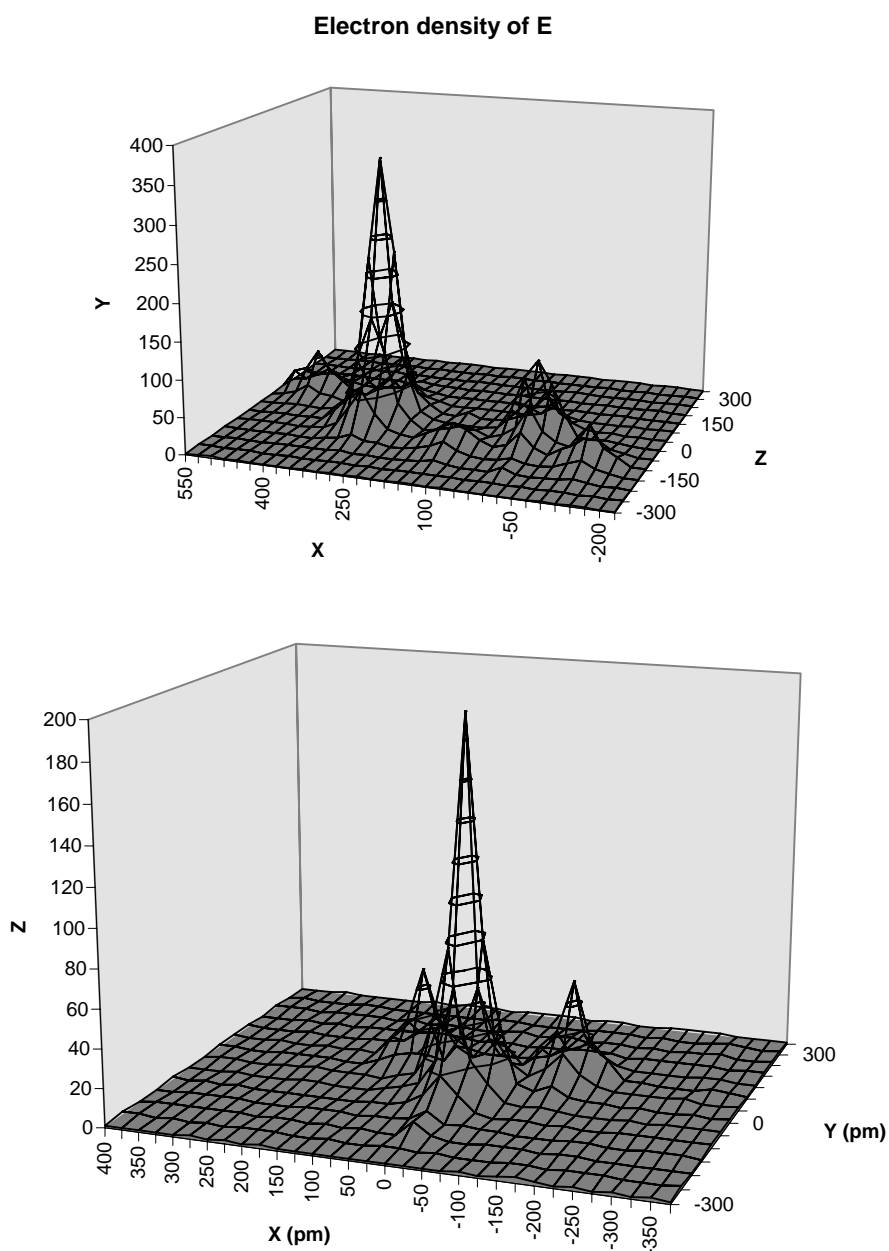
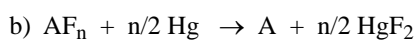

Fig. 12 Electron density distribution of E



$$n_A = \frac{pV}{RT} = \frac{101000 \cdot 5.325 \cdot 10^{-5}}{298 \cdot 8.314} \frac{\text{Nm}^3 \text{molK}}{\text{m}^2 \text{JK}} = 2.17 \cdot 10^{-3} \text{ mol of A} = n_{\text{AF}}$$

$$\underline{M_{\text{AFn}}} = 0.45 / 2.17 \cdot 10^{-3} = \underline{207.4 \text{ g/mol}} = M_A + nM_F$$

$$nM_F = 0.367 M_{AF_n} \Rightarrow n = (207 \cdot 0.367) / 19 = 4.0055 \Rightarrow \underline{AF_4}; \underline{M_A} = M_{AF_n} - nM_F = 207.4 - 76.1 = \underline{131.3 \text{ g/mol}}$$

c) A: Xe B: XeF₂ C: XeF₄ D: XeI₆ E: XeF(OSO₂F)

d) The molecular structures can easily be explained combining all binding orbitals of fluor with the occupied orbitals of the inert gas to equal electron pairs which form a structure such that their repulsion becomes minimal.

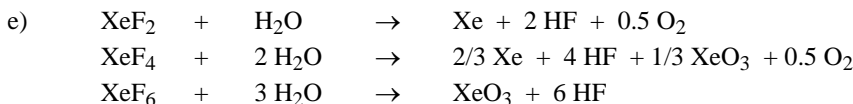

$$\begin{aligned} \text{f)} \quad n_{\text{gas}} &= \frac{pV}{RT} = \frac{100000 \cdot 53.25 \cdot 10^{-6}}{8.314 \cdot 290} \frac{\text{Nm}^3\text{Kmol}}{\text{m}^2\text{JK}} = 2.50 \cdot 10^{-3} \text{ mol} \\ n(\text{O}_2) &= 0.4 \cdot n_{\text{gas}} = 1.00 \cdot 10^{-4} \text{ mol} \end{aligned}$$

Assuming that $n(\text{XeF}_2) = a$; $n(\text{XeF}_4) = b$; $n(\text{XeF}_6) = c$ gives the following results

$$\begin{aligned} \Rightarrow \quad n(\text{Xe}) &= a + 2/3 b; \quad n(\text{O}_2) = 1/2 a + 1/2 b; \\ n_{\text{gas}} &= n(\text{Xe}) + n(\text{O}_2) = 3/2 a + 7/6 b = 2.50 \cdot 10^{-3} \text{ mol} \\ n(\text{O}_2) &= 1/2 a + 1/2 b = 1.00 \cdot 10^{-3} \text{ mol} \\ \Rightarrow \quad a &= 0.5 \cdot 10^{-3} \text{ mol}; \quad b = 1.5 \cdot 10^{-3} \text{ mol} \end{aligned}$$

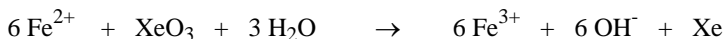

$$\begin{aligned} n(\text{XeO}_3) &= 1/6 n(\text{Fe}^{2+}) = 1/6 [c(\text{Fe}^{2+}) v(\text{Fe}^{2+})] = 1/6 \cdot 0.100 \cdot 36.0 \cdot 10^{-3} \text{ mol} = 6.00 \cdot 10^{-4} \text{ mol} = 1/3 b + c \\ \Rightarrow \quad c &= 0.6 \cdot 10^{-3} - 0.5 \cdot 10^{-3} = 1 \cdot 10^{-4} \end{aligned}$$

Thus the molar composition can be obtained:

molar composition:

$$\begin{aligned} \text{XeF}_2: & 0.5 \cdot 10^{-3} \text{ mol} \quad (23.8\%) \\ \text{XeF}_4: & 1.5 \cdot 10^{-3} \text{ mol} \quad (71.4\%) \\ \text{XeF}_6: & 1 \cdot 10^{-4} \text{ mol} \quad (4.8\%) \end{aligned}$$

IChO Halle 1989

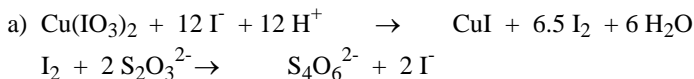

$$\text{b)} \quad c(\text{Cu}^{2+}) = \frac{0.1 \cdot 0.03 \cdot 1}{2 \cdot 6.50 \cdot 0.02} \frac{\text{mol} \cdot \text{l}}{\text{l} \cdot \text{l}} = 1.15 \cdot 10^{-2} \text{ mol/l}$$

$$c(\text{IO}_3^{2-}) = 2 c(\text{Cu}^{2+}) \text{ thus } K_{\text{sp}} = [\text{Cu}^{2+}] [\text{IO}_3^{2-}]^2 = 4 [\text{Cu}^{2+}]^3 = \underline{6.08 \cdot 10^{-6} \text{ mol}^3/\text{l}^3}$$

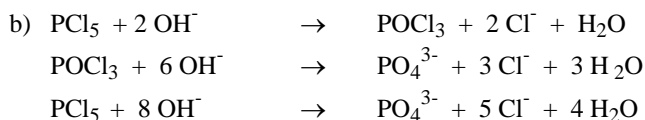
IChO Hallo 1989

$$\text{c) } A = A_0 e^{-\lambda t} \quad t_{1/2}: A = 0.5 A_0 \Rightarrow \lambda = \ln 2 / t_{1/2} \quad A = 10^{-3} A_0$$

$$t = \frac{\ln A - \ln A_0}{-\lambda} = -\frac{\ln 10^{-3}}{\frac{\ln 2}{14.3}} d = 142.5 d$$

d)

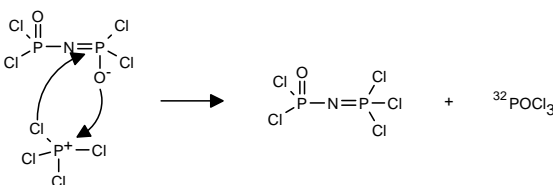
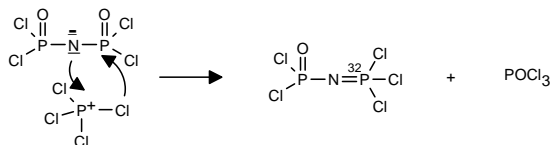

- e) Specific activities $A_{\text{sp}}(\text{II}) = 18.6 \text{ Bq/mg}$ Because of $A_{\text{sp}}(\text{II}) \approx A_{\text{sp}}(\text{IV})$ the second mechanism proposed in d) is probable and therefore it's PCl_4^+ that attacks the O-atom.
 $A_{\text{sp}}(\text{III}) = 0.18 \text{ Bq/mg}$
 $A_{\text{sp}}(\text{IV}) = 18.5 \text{ Bq/mg}$

f) Given: $K_{\text{sp}} = [\text{Mg}^{2+}][\text{NH}_4^+][\text{PO}_4^{3-}] = 10^{-12.6}$; $[\text{NH}_4] = 0.1$; $\text{pH} = 10$, $\text{p}K_1 = 2.2$, $\text{p}K_2 = 7.2$, $\text{p}K_3 = 12.4$

exact solution:

$$2 [\text{Mg}^{2+}] + [\text{NH}_4^+] + [\text{H}_3\text{O}^+] = [\text{H}_2\text{PO}_4^-] + 2 [\text{HPO}_4^{2-}] + 3 [\text{PO}_4^{3-}] + [\text{OH}^-]$$

$$[\text{HPO}_4^{2-}] = [\text{PO}_4^{3-}] [\text{H}^+] / K_3$$

$$[\text{H}_2\text{PO}_4^-] = [\text{PO}_4^{2-}] [\text{H}^+] / K_2 = [\text{PO}_4^{3-}] [\text{H}^+]^2 / (K_2 K_3)$$

$$[\text{PO}_4^{3-}] = K_{\text{sp}} / ([\text{NH}_4^+] [\text{Mg}^{2+}])$$

$$\rightarrow 2 [\text{Mg}^{2+}] = ([\text{H}^+]^2 / (K_1 K_3) + 2 [\text{H}^+] / K_3 + 3)(K_{\text{sp}} / [\text{NH}_4^+]) - [\text{Mg}^{2+}]([\text{NH}_4^+] + [\text{H}^+] - [\text{OH}^-])$$

etc.

simpler solution:

at $\text{pH} = 10$ the main component is HPO_4^{2-} : $[\text{HPO}_4^{2-}] = [\text{PO}_4^{3-}] [\text{H}^+] / K_3 = 10^{-2.4} [\text{PO}_4^{3-}]$

$$[\text{H}_2\text{PO}_4^-] = [\text{HPO}_4^{2-}] [\text{H}^+] / K_2 = 10^{-2.8} [\text{HPO}_4^{2-}]$$

$$L = [\text{Mg}^{2+}] [\text{HPO}_4^{2-}] \text{ and } K_{\text{sp}} = [\text{NH}_4^+] \cdot L \cdot K_3 \cdot L / [\text{H}^+]$$

$$pL = 0.5 (pK_{\text{sp}} + \text{pH} - pK_3 - p[\text{NH}_4^+]) = 0.5 (12.6 + 10.0 - 12.4 - 1.0) = 4.6; \quad L = 2.5 \cdot 10^{-5} \text{ mol/l}$$

IChO Paris 1990

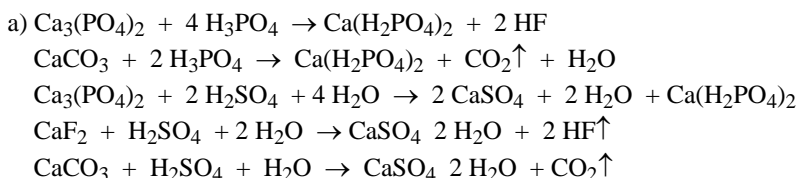

1g apatite contains $0.284/142 = 2.00 \cdot 10^{-3}$ mol of $\text{Ca}_3(\text{PO}_4)_2$

$$0.034/(2 \cdot 19) = 0.89 \cdot 10^{-3} \text{ mol of CaF}_2$$

$$0.061/44 = 1.39 \cdot 10^{-3} \text{ mol of CaCO}_3$$

$$0.035/80 = 0.44 \cdot 10^{-3} \text{ mol of CaSO}_4$$

$$0.473/56 - 3 \cdot 0.284/142 - 0.034/38 - 0.061/44 - 0.035/80 = - 2.72 \cdot 10^{-4} \text{ mol CaO that}$$

remain

The amount of H_3PO_4 needed to react with 1g apatite is equal to $n(\text{H}_3\text{PO}_4) = 4 n(\text{Ca}_3(\text{PO}_4)_2) + 2 n(\text{CaF}_2) + 2 n(\text{CaCO}_3) = 12.56 \cdot 10^{-3}$ mol. 50 ml of the acid contains $25 \cdot 10^{-3}$ mol of H_3PO_4 , therefore $25/12.56 = 1.99$ g apatite is needed to neutralize the H_3PO_4 present.

The amount of H_2SO_4 needed to react with 1g apatite can be calculated in the same way:

$n(\text{H}_2\text{SO}_4) = 2 n(\text{Ca}_3(\text{PO}_4)_2) + n(\text{CaF}_2) + n(\text{CaCO}_3) = 6.28 \cdot 10^{-3}$ mol. 50 ml of the acid contains $5.00 \cdot 10^{-3}$ mol sulphuric acid. Therefore $5/6.28 = 0.80$ g apatite is needed to neutralize the H_2SO_4 .

The total amount of apatite is $m_0 = 1.99 + 0.80 = 2.79$ g

b) Formation of $\text{Ca}(\text{H}_2\text{PO}_4)_2$:

1.99g of apatite needed to neutralize the H_3PO_4 contains $1.9 \cdot 2.00 \cdot 10^{-3}$ mol $\text{Ca}_3(\text{PO}_4)_2$, so there is $3 \cdot 2 \cdot 2 \cdot 10^{-3} = 1.2 \cdot 10^{-2}$ mol of dihydrogenophosphate being formed. From CaF_2 , $1.99 \cdot 0.89 = 1.80$ mol and from CaCO_3 , $1.99 \cdot 1.39 = 2.77$ mol $\text{Ca}(\text{H}_2\text{PO}_4)_2$ are formed. 0.8g of apatite that reacts with 50 ml of the sulfuric acid and yields $2 \cdot 0.8 \cdot 10^{-3} = 1.6 \cdot 10^{-3}$ mol $\text{Ca}(\text{H}_2\text{PO}_4)_2$.

$$m(\text{Ca}(\text{H}_2\text{PO}_4)_2) = 18.07 \cdot 10^{-3} \text{ mol} = 4.230 \text{ g}$$

$$\text{Formation of gypsum: } m(\text{CaSO}_4) = m(\text{H}_2\text{SO}_4) = 5.00 \cdot 10^{-3} \text{ mol} = 0.86 \text{ g}$$

The amount of CaSO_4 that was already present in 1g apatite and yielded gypsum is $0.434 \cdot 10^{-3} \cdot 172 = 0.075$ g. There remain also 0.034 g of silica, so the theoretical mass of the residue should be:

$$m_{\text{th}} = 4.230 + 0.86 + (0.0753 + 0.034) \cdot 2.79 = 5.39 \text{ g}$$

The difference of 0.1 g may be due to water and unreacted CaF_2 in the residue.

c) The second reaction is intended to dissolve $\text{Ca}(\text{H}_2\text{PO}_4)_2$, all the other products remaining on the filter. According to the yielded residue of 0.144g, 1g residue contains $1 - 0.144 = 0.856$ g soluble product. If it were all $\text{Ca}(\text{H}_2\text{PO}_4)_2$ it would correspond to $0.856 / 234 = 3.66 \cdot 10^{-3}$ mol. For 5.49 g of residue it is $0.0201 \cdot 10^{-3}$ mol soluble product (n_2). The amount of acid used is $0.500 / 20 = 0.025$ mol H_3PO_4 (equals 0.0125 mol P_2O_5) and 0.005 mol H_2SO_4 . The amount of $\text{Ca}_3(\text{PO}_4)_2$ in 2.79 g apatite is 0.00558 mol (equals 0.00558 mol P_2O_5). So, $r_{\text{exp}} = 100 \cdot [0.0201 / (0.0125 + 0.00558)] = 111\%$

Since 50 ml water dissolve 0.115 g of gypsum, the real quantity of $\text{Ca}(\text{H}_2\text{PO}_4)_2$ is $0.856 - 0.115 = 0.741$ mol, so that the real yield gives: $r_{\text{exp}} = 100 \cdot [0.0174 / (0.0125 + 0.00558)] = \underline{96\%}$.

The theoretical value for r_{exp} is: $r_{\text{exp}} = 100 \cdot [4.23/234 / (0.0125 + 0.00558)] = 100\%$, so this calculation makes sense.

IChO Paris 1990

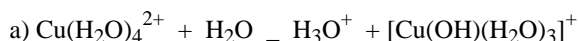

$$K_a = \frac{[\text{H}_3\text{O}^+][\text{Cu}(\text{OH})(\text{H}_2\text{O})_3^+]}{[\text{Cu}(\text{H}_2\text{O})_4^{2+}]} = \frac{[\text{H}_3\text{O}^+]^2}{10^{-2} - [\text{H}_3\text{O}^+]}$$

$$\text{p}K_a = 2\text{pH} + \log(10^{-2} - 10^{-\text{pH}}) = 9.30 - 2 = 7.30$$

$$[\text{Cu}^{2+}][\text{OH}^-]^2 = 10^{-20}; [\text{Cu}^{2+}] = 10^{-2} \text{ mol/l} \Rightarrow [\text{OH}^-] = 10^{-9}; \underline{\text{pH} = 5}$$

$$[\text{Cu}(\text{OH})(\text{H}_2\text{O})_3^+] : [\text{Cu}(\text{H}_2\text{O})_4^{2+}] = K_a : 10^{-\text{pH}} = 10^{-7.4} : 10^{-5} = 1 : 200$$

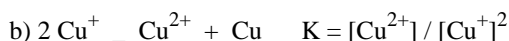

$$0.52 - 0.16 = 0.059 \lg K \text{ (Nernst equation)} \Rightarrow K = 10^6 \text{ mol}^{-1} \text{ l}^{-1}$$

at equilibrium: $[\text{Cu}^+] + 2 [\text{Cu}^{2+}] = 10^{-2}$ and $[\text{Cu}^{2+}] = 10^6 [\text{Cu}^+]$ so that the following equation is obtained:

$$2 \cdot 10^6 [\text{Cu}^+]^2 + [\text{Cu}^+] - 10^{-2} = 0 \text{ with the solution } [\text{Cu}^+] = \underline{7.07 \cdot 10^{-5}} \text{ mol/l and } [\text{Cu}^{2+}] = \underline{4.96 \cdot 10^{-3}} \text{ mol/l.}$$

other disproportionation reactions: $\text{H}_2\text{O}_2 \rightarrow \text{H}_2\text{O} + 0.5 \text{O}_2$ (catalyzed by KMnO_4 , Fe^{3+} etc.)

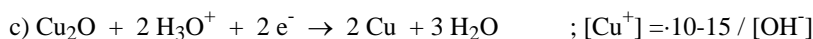
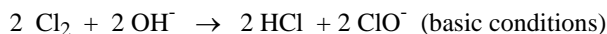

$$E_1 = 0.52 + 0.059/2 \log ([\text{Cu}^+] [\text{H}_3\text{O}^+]^2) = 0.49 - 0.0885 \text{ pH}$$

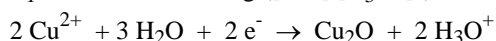

$$E_2 = 0.16 + 0.059/2 \log (10^{-4} / ([\text{Cu}^+] [\text{H}_3\text{O}^+]^2)) = 0.07 + 0.0885 \text{ pH}$$

CuO_2 is stable when $E_2 > E_1$ i.e. $0.42 < 0.177 \text{ pH}$, or $\text{pH} > 2.4$

Cu_2O can be obtained by the reduction of Cu^{2+} in acid or basic media, e.g. by Fehling's solution or reducing sugars.

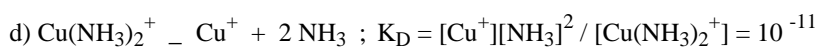

knowing $E^0(\text{Cu}^+/\text{Cu}) = 0.52$, the $E^0(\text{Cu}(\text{NH}_3)_2^+ / \text{Cu}^+)$ becomes: $E_{f1} = 0.52 - 0.06 \text{ p}K_D = \underline{-0.14 \text{ V}}$

e) The standard emf of a Cu^{2+}/Cu cell is thus: $E^0 = (0.5 + 0.16)/2 = 0.34 \text{ V}$ and $E_3^0 = 0.34 - 0.03 \text{ p}K_2$.

$$\text{Thereout: } \text{p}K_2 = (0.34 - E_3^0)/0.03 = (0.34 - (-0.02))/0.03 = \underline{12}$$

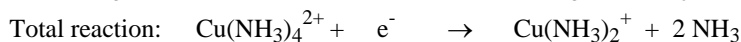
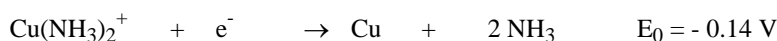
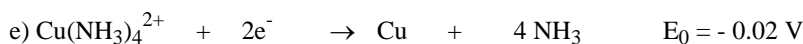

Since only ΔG^0 is additive and from $\Delta G^0 = -nFE^0$ it follows: $E_{f2} = 2 \cdot (-0.02) - (-0.14) = 0.10 \text{ V}$

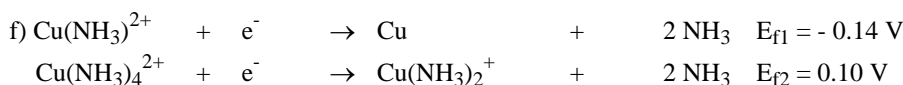

Since $E_{f1} < E_{f2}$ the $\text{Cu}(\text{NH}_3)_2^+$ ion doesn't disproportionate (the e.m.f would be $-0.14 - 0.10 = -0.24 \text{ V}$)

IChO Lodz 1991

Three processes may be observed when dissolving metallic sulphides in acids:

- binding of S^{2-} ions into undissociated HS^- and H_2S
- formation of metal - anion complexes
- oxidation of S^{2-} ions to free sulphur

a) $c(\text{Ti}^+) = 0.2 \text{ mol/l}$

$$c(\text{S}^{2-}) = [\text{S}^{2-}] + [\text{HS}^-] + [\text{H}_2\text{S}] = [\text{S}^{2-}] (1 + [\text{H}^+]/K_2 + [\text{H}^+]^2/K_1K_2) = 0.1 \text{ mol/l}$$

$$\text{solubility conditions: } [\text{Ti}^+]^2 [\text{S}^{2-}] < 10^{-20}$$

For a strong monoprotic acid (1M), $[\text{H}^+]$ is certainly greater than 0.1 mol/l :

$$[\text{S}^{2-}] = 0.1 / (1 + [\text{H}^+]/K_2 + [\text{H}^+]^2/K_1K_2) = 10^{-19} \text{ mol/l} \Rightarrow [\text{Ti}^+]^2 [\text{S}^{2-}] = 0.04 [\text{S}^{2-}] = 4 \cdot 10^{-21} < K_{sp}$$

(Ti_2S)

b) Dissolving CuS in HCl (nonoxidizing and noncomplexing acid):

$$[\text{Cu}^{2+}] = 0.1 \text{ mol/l}$$

In order to dissolve 0.1 mol of CuS , the concentration of $[\text{S}^{2-}]$ must be lower than $K_{sp}(\text{CuS})/0.1$:

$$[\text{S}^{2-}] = 0.1 / (1 + [\text{H}^+]/K_2 + [\text{H}^+]^2/K_1K_2) < 10^{-34}$$

$$1 + [\text{H}^+]/K_2 + [\text{H}^+]^2/K_1K_2 > 10^{33} \Rightarrow [\text{H}^+] > 3.2 \cdot 10^6 \text{ mol/l which is impossible to obtain !}$$

When dissolving in 1M HNO_3 an additional redox process occurs, the oxidation of S^{2-} to S .

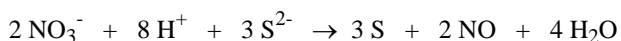

$$\text{The e.m.f of this reaction is } \Delta E = E_1^0 - E_2^0 = (0.96 + 0.48) = \underline{1.44 \text{ V}}$$

The equilibrium constant of this process is:

$$K = \frac{[\text{S}]^3 \cdot [\text{NO}]^2 \cdot [\text{H}_2\text{O}]^4}{[\text{S}^{2-}]^3 \cdot [\text{H}^+]^8 \cdot [\text{NO}_3^-]^2}$$

$$c_{\text{CuS}} = [\text{S}] + [\text{H}_2\text{S}] + [\text{HS}^-] + [\text{S}^{2-}]$$

From the above equilibrium follows that $[\text{S}]^3 = K[\text{NO}_3^-]^2[\text{H}^+]^8/[\text{NO}]^2$ and therefore $[\text{S}^{2-}]$ is equal to:

$$\log K = -\frac{\Delta G}{RT} = \frac{nF}{RT} \cdot \Delta E = \frac{n_1 n_2 (E_1^0 - E_2^0)}{0.0591} \cong 146$$

$$[\text{S}^{2-}] = \frac{c_{\text{CuS}}}{1 + \frac{[\text{H}^+]}{K_1} + \frac{[\text{H}^+]^2}{K_1K_2} + \sqrt[3]{\frac{K[\text{NO}_3^-]^2[\text{H}^+]^8}{[\text{NO}]^2}}} = \frac{c_{\text{CuS}}}{5.40 \cdot 10^{49}} = 1.86 \cdot 10^{-51} \text{ mol/l}$$

for CuS: $[Cu^{2+}][S^{2-}] = 1.86 \cdot 10^{-52} \text{ mol}^2/l^2 \ll K_{sp}(\text{CuS})$ which means that CuS dissolves easily in 1M HNO_3 .

IChO Lodz 1991

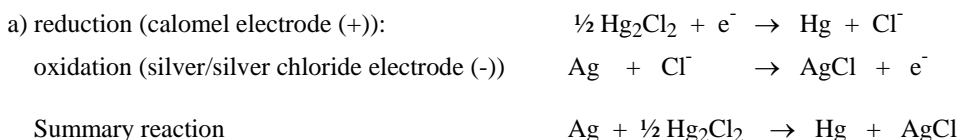

b) $\Delta G^0 = -nFE^0 = -4.39 \text{ kJ/mol}$; Since ΔG^0 is negative, the reaction is spontaneous.

c) The change of enthalpy is related to the Gibbs-Helmholtz equation:

$$\Delta H = \Delta G + T\Delta S = -nFE + nFT(\Delta E/\Delta T) = -nF(E - T(\Delta E/\Delta T)) = 5.33 \text{ kJ/mol}$$

d) For the $Ag | Ag^+$ electrode $E = E^0 + 0.0591 \log[Ag^+]$

For the $Ag, AgCl | Cl^-$ electrode $[Ag^+]$ is determined by the solubility product: $[Ag^+] = K_{sp} / [Cl^-]$

$$E^0(Ag, AgCl | Cl^-) = E^0(Ag | Ag^+) + 0.0591 \log K_{sp} = 0.799 - 0.577 = 0.222 \text{ V}$$

e) $E^0(Hg, Hg_2Cl_2 | Cl^-) = E^0(Hg | Hg^{2+}) + 0.0591/2 \log K_{sp}(Hg_2Cl_2)$

The standard potential of the calomel electrode is equal to $0.0455 + 0.222 = 0.2675 \text{ V}$. So, $\log K_{sp}(Hg_2Cl_2)$ can be calculated as: $\log K_{sp}(Hg_2Cl_2) = 2(0.2675 - 0.799)/0.0591 = -17.99$

K_{sp} is equal to $1.03 \cdot 10^{-18}$

IChO Pittsburgh 1992

a) In five years a whale eats carbohydrates coming from $5 \cdot 365 \cdot 75 \cdot 10 = 1.4 \cdot 10^6 \text{ kg}$ krill which themselves need $1.4 \cdot 10^7 \text{ kg}$ of carbohydrates coming from diatoms. For $180 \text{ g } C_6H_{12}O_6$, $6 \cdot 44 \text{ g } CO_2$ is necessary, so for $1.4 \cdot 10^7 \text{ kg}$ $1.4 \cdot 10^7 \cdot (264/180) = 2.00 \cdot 10^7 \text{ kg}$ of CO_2 are needed which is $1.0 \cdot 10^{10} \text{ litres}$.

b) The amount of water is $4 \cdot 10^{13} \text{ l}$ (0.03 %).

c) The mass of nitrogen from a whale is $0.03 \cdot 9.1 \cdot 10^4 \text{ kg} = 2.7 \cdot 10^6 \text{ g}$.

$$\text{mol N} = \text{mol } NH_4^+ = 2.7 \cdot 10^6 / 14 = 1.9 \cdot 10^5 \text{ mol} \cong 3 \cdot 10^3 \text{ kg } NH_4^+$$

d) One whale contains $1.6 \cdot 10^4 \text{ kg}$ of carbon which is $1.3 \cdot 10^6 \text{ mol}$ of CO_2 freed and $6.5 \cdot 10^5 \text{ mol}$ $CaSiO_3 \cong 7.5 \cdot 10^7 \text{ g } CaSiO_3$ thus formed. 1000 whales therefore produce $7.5 \cdot 10^3 \text{ g } CaSiO_3$.

IChO Pittsburgh 1992

a) a₁) NO_3^- a₂) N_2

b) b₁) MnO_2 b₂) $Mn(OH)_2$

c) The black solid is MnO_2 , which corresponds to Mn^{2+} when oxygen is absent.

- d) NO_3^- and N_2 . In practice only NO_3^- would oxidize Mn, since the activation energy for N_2 in order to break the triple bonds is very high.
- e) Mn_3O_4 , Mn_2O_3 , MnO_2 , MnO_4^- , MnO_4^{2-}
- f) NH_4MnO_4 is thermodynamically stable whereas $(\text{NH}_4)_2\text{MnO}_4$ is not.
- g) $2 \text{NH}_4\text{MnO}_4 \rightarrow 4 \text{H}_2\text{O} + 2 \text{MnO}_2 + \text{N}_2$
 $(\text{NH}_4)_2\text{MnO}_4 \rightarrow 4 \text{H}_2\text{O} + \text{Mn} + \text{N}_2$
- h) According to the diagrams, KNO_3 is easily reduced by Mn whereas the potential of MnO_2 is more positive than the potential of NO_3^- . So a mixture of KNO_3 and Mn could be explosive.
- i) $E = E^0 + 0.0591/3 \log([\text{MnO}_4^-][\text{H}^+]^4) = 1.692 \text{ V} + 0.0197 \log(0.001 \cdot 10^{-16}) = \underline{1.34 \text{ V}}$

IChO Perugia 93

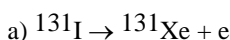

b) Decay reactions are first order reactions. Then:

$$k = \frac{\ln 2}{t_{1/2}} \text{ and therefrom: } t_{1/2} = \frac{\ln 2}{k} = \frac{0.693}{9.93 \cdot 10^{-7} \text{ s}^{-1} \cdot 86400 \text{ s d}^{-1}} = 8.08 \text{ d}$$

c) For a first order reaction:

$$\ln \frac{C_0}{C} = kt$$

where C_0 and C are the concentrations at time 0 and time t , respectively. Solving for t yields then:

$$\ln \frac{100}{30} = 9.93 \cdot 10^{-7} \cdot t \text{ and } t = \frac{1.212 \cdot 10^6}{8.64 \cdot 10^4} = 14.03 \text{ d}$$

d)

$$\frac{dN}{dt} = -10^{-4} \mu\text{c} \cdot 3.7 \cdot 10^4 \text{ dis / s} = -3.7 \text{ dis / s}$$

$$m = -\frac{dN}{dt} \cdot \frac{t_{1/2} \cdot u(^{131}\text{I})}{N_A \cdot \ln 2} = \frac{3.7 \cdot 8.08 \cdot 86400 \cdot 131 \text{ dis} \cdot \text{s} \cdot \text{g} \cdot \text{mol}}{6.02 \cdot 10^{23} \cdot 0.693 \text{ s} \cdot \text{mol} \cdot \text{dis}} = 8.11 \cdot 10^{-16} \text{ g}$$

3. Physical chemistry

IChO Leiden 1986

a) $\lambda = c/v = 2l/n$ with $n = 1, 2, 3, \dots$

b)

$$E = \frac{h \cdot c}{h} = \frac{m \cdot v^2}{2} = \frac{p^2}{2m}; \quad p = \frac{h}{\lambda} = \frac{h \cdot n}{2l} \Rightarrow E_n = \frac{h^2 \cdot n^2}{8ml^2} = \frac{h^2}{8ml^2} \cdot (n_{\text{homo}}^2 - n_{\text{lumo}}^2)$$

c) For k electrons and $k \equiv 0 \pmod{2}$, $k/2$ orbitals are possible, so $n_{\text{homo}} = k/2$ and $n_{\text{lumo}} = k/2 + 1$

$$\Delta E_n = \frac{h^2}{8ml^2} [(1/2k + 1)^2 - 1/2k^2] = \frac{h^2}{8ml^2} \cdot (k + 1) \Rightarrow \lambda = \frac{h \cdot c}{\Delta E} = \frac{8mcl^2}{h(k + 1)}$$

d) if N is the number of C-Atoms N is equal to k+1 for even number of electrons k, so

$$\lambda = \frac{8mcl^2}{Nh} = \frac{8mcl^2}{h(k + 1)}$$

for even N's, the length of the box would be a(N-1) with k = N electrons, so

$$\lambda = \frac{8mc(N-1)^2 a^2}{h(N+1)}$$

e) For a conjugated system N has to be even. To obtain a visible colour, the wavelength should be greater than 400 nm. Therefore

$$\frac{8mc(N-1)^2 a^2}{h(N+1)} \geq 4 \cdot 10^{-7} \text{ and accordingly: } \frac{(N-1)^2}{N+1} \geq 6.02$$

The equation $N^2 - 8.02N - 5.02 > 0$ derived from the equation above has the only positive solution $N = 8.60$. Since N must be even, the minimum number of C-Atoms is 10.

f) The angles between 5-6 and 7-8, between 11-12 and 13-14 are smaller than 90° and therefore the effect of the double bonds between C5 and C6, C13, C14 and O can't be neglected. They overlap to a small extent with the conjugated system C7 through C12 and enlarge the box significantly. A larger l leads to a larger λ , causing a shift towards a longer wavelength.

g) Obviously, the box must be much larger when bound to opsin. For $\lambda = 600 \text{ nm}$ the atoms C5 to O at the end of the chain must be forced into the plane:

$$l = 0.133 + 0.150 + 4 \cdot (0.134 + 0.148) + 0.120 = 1.54 \text{ nm; } k = 12; \lambda = 3.30 \cdot 10^{12} l^2 / (k+1) = \underline{602 \text{ nm}}$$

IChO Helsinki 1988

a) $M_f(\text{C}_8\text{H}_{18}) = 114.0$, Cylinder volume (V_0) = $4.00 \cdot 10^{-4} \text{ m}^3$, $P_0 = 101000 \text{ Nm}^{-2}$, $T_0 = 373 \text{ K}$

Considering one cylinder during one burn cycle one obtains:

$$m_f = 0.400/25 \text{ g} = 0.0160 \text{ g, } n_f = 1.4004 \cdot 10^{-4} \text{ mol}$$

$$n_G = n_f + n_A = P_0 V_0 / (RT_0) = 0.0130 \text{ mol} \quad (n_G: \text{ number of moles of gases, } n_A: \text{ moles of air})$$

$$\Rightarrow n_A = 0.0129 \text{ mol}$$

$$\Rightarrow \text{Air intake of one cylinder during 25 burn cycles: } V_A = 25 n_A RT_0 / P_0 = 9.902 \cdot 10^{-3} \text{ m}^3/\text{s}$$

$$\Rightarrow \text{The air intake of the whole engine is therefore: } V_{\text{Total}} = 4V_A = 0.0396 \text{ m}^3/\text{s}$$

b) The composition of the exhaust gases of one cylinder during one burn cycle is considered:

$$\text{before: } n_{\text{O}_2} = 0.21 n_A = 2.709 \text{ mmol}$$

$$n_{\text{N}_2} = 0.79 n_A = 10.191 \text{ mmol}$$

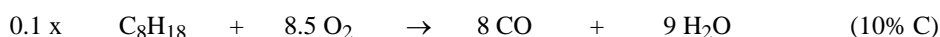

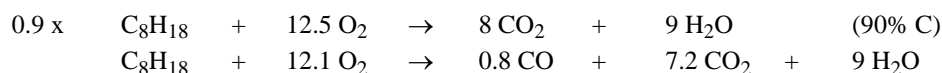

No of moles:

before comb.	$1.404 \cdot 10^{-4}$	$2.709 \cdot 10^{-3}$	0	0	0
after comb.	0	$10 \cdot 10^{-4}$	$1.123 \cdot 10^{-4}$	$10.11 \cdot 10^{-4}$	$12.63 \cdot 10^{-4}$

The composition of the gas after combustion is therefore:

Component	N ₂	O ₂	CO	CO ₂	H ₂ O	Total
mol·10 ⁴	101.91	10.10	1.12	10.11	12.63	135.87
%	75.0	7.4	0.8	7.5	9.3	100

c) From thermodynamics the relation between the enthalpy and temperature change is given by

$$\Delta H = \int_{T_1}^{T_2} \sum_{i=1}^{i=k} c_{pi} n_i dT = \sum_{i=1}^{i=k} c_{pi} n_i (T_2 - T_1)$$

$$\Delta H = n_f [0.8 \Delta H_f(\text{CO}) + 7.2 \Delta H_f(\text{CO}_2) + 9 \Delta H_f(\text{H}_2\text{O}) - \Delta H_f(\text{C}_8\text{H}_{18})] = -0.6914 \text{ kJ}$$

This yields to: $691.4 = 0.4097 (T_2 - 373)$ and $T_2 = \underline{2060 \text{ }^\circ\text{C}}$

c) $P_2 = 200000 \text{ Pa}$, $V_0 = 4.00 \cdot 10^{-4} \text{ m}^3$, $n_G =$ moles of exhaust gases in one cylinder = 0.01359 mol
 $T_2 = (P_2 V_0) / (n_G R) = \underline{708 \text{ K}}$

d) The flow from all four cylinders is given: $v = 4 \cdot 25 \cdot n_G = 1.359 \text{ mol/s}$, so that

$$\frac{n(\text{CO})}{n(\text{CO})_2} = 0.25 \cdot 3.141 \cdot \frac{1.12 \cdot 10^{-4}}{10.11 \cdot 10^{-4}} \cdot 1.359 \cdot e^{-(708/373)} = 0.01772$$

During catalysis:	CO	+	0.5 O ₂	→	CO ₂
in moles·10 ⁴ (4 cylinders)					
initial	4.48		40.40		40.44
final	4.48 - x		40.40 - 0.5 x		40.44 + x

$$0.01772(40.44 + x) = 4.48 - x \Rightarrow x = 3.70$$

So, the composition of the gas after the catalyst is:

Component	N ₂	O ₂	CO	CO ₂	H ₂ O	Total
mol·10 ⁴	407.64	40.40-0.5x	4.48-x	40.44+x	50.52	541.63
		38.55	0.78	44.14		
%	75.26	7.12	0.15	8.14	9.33	100

IChO Helsinki 1988

- a) In the two dimensional world and the electron quantum numbers given, we obtain the following Flatlandian periodic table:

1 $1s^1$									2 $1s^2$
3 $2s^1$	4 $2s^2$					5 $2s^2 2p^1$	6 $2s^2 2p^2$	7 $2s^2 2p^3$	8 $2s^2 2p^4$
9 $3s^1$	10 $3s^2$					11 $3s^2 3p^1$	12 $3s^2 3p^2$	13 $3s^2 3p^3$	14 $3s^2 3p^4$
15 $4s^1$	16 $4s^2$	17 $4s^2 3d^1$	18 $4s^2 3d^2$	19 $4s^2 3d^3$	20 $4s^2 3d^4$	21 $4s^2 3d^4 4p^1$	22 $4s^2 3d^4 4p^2$	23 $4s^2 3d^4 4p^3$	24 $4s^2 3d^4 4p^4$

- b) sp^1 and sp^2 hybrid orbitals are possible:

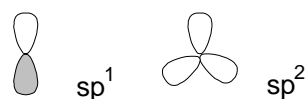

The element of life is the element with $Z=5$. The corresponding compounds of ethane, ethene and cyclohexane are:

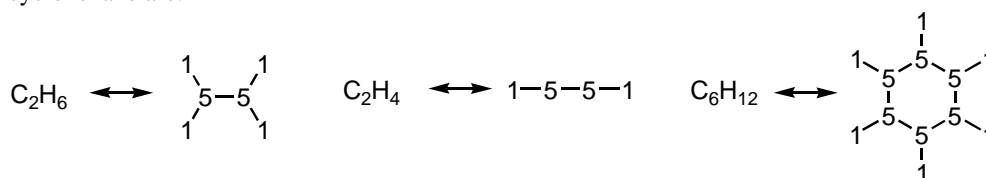

Aromatic ring compounds are not possible since there are no electron orbitals left that may overlap in the case of sp^2 .

- c) The octet rule is changed to a sextet rule, the 18-electron rule corresponds to a 14-electron rule.
 d) The ionization energies and the trends in electronegativity

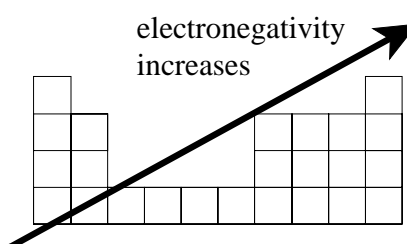
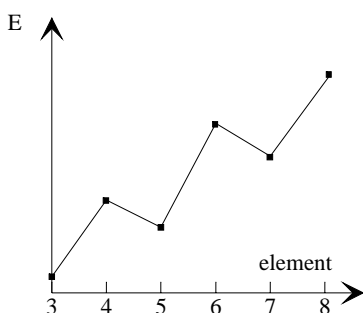

- e) The molecular orbital diagram of the homonuclear X_2 molecules:

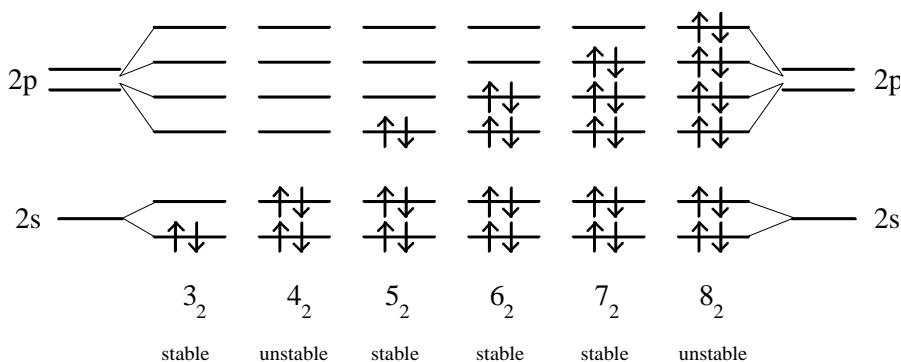

f) The Lewis structures and geometries: $3:1$ $1:4:1$ $\begin{array}{c} \cdot \\ \vdots \\ 1 \cdot 5 \cdot 1 \\ \vdots \\ 1 \end{array}$ $\begin{array}{c} \cdot \\ \vdots \\ 1 \cdot 6 \cdot 1 \\ \vdots \\ 1 \end{array}$ $\begin{array}{c} \cdot \\ \vdots \\ \cdot 7 \cdot \\ \vdots \\ \cdot \end{array}$

g) The three-dimensional analogs of Flatlandian elements are:

1: H, gas	5: B or C, solid	9: Na, solid	13: Cl, gas
2: He, gas	6: N or O, gas	10: Mg, solid	14: Ar, gas
3: Li, solid	7: F, gas	11: Al or Si, solid	
4: Be, solid	8: Ne, gas	12: P or S, solid	

IChO 1989 Halle

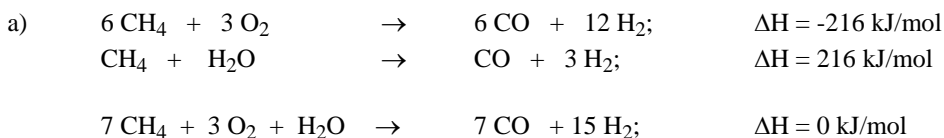

b1) For a pressure increase in two steps under the conditions given, the work of compression is:

$$W_2 = n_1 RT \ln \frac{p_1}{p_0} + n_2 RT \ln \frac{p_2}{p_1} = n_1 RT (\ln \frac{p_1}{p_0} + 2 \ln \frac{p_2}{p_1})$$

$$= 100 \text{ mol} \cdot 8,314 \text{ J mol}^{-1} \text{ K}^{-1} \cdot 500 \text{ K} \left(\ln \frac{3.0 \text{ MPa}}{0.1 \text{ MPa}} + 2 \ln \frac{6.0 \text{ MPa}}{3.0 \text{ MPa}} \right) = 1.99 \text{ MJ}$$

2) For a pressure increase in one step the work of compression only depends on n_2 , p_2 and p_0 :

$$W_1 = n_2 RT \ln \frac{p_2}{p_0} = 200 \text{ mol} \cdot 8,314 \text{ J mol}^{-1} \text{ K}^{-1} \cdot 500 \text{ K} \ln \frac{6.0 \text{ MPa}}{0.1 \text{ MPa}} = 3.40 \text{ MJ}$$

$$\Rightarrow \Delta W = W_1 - W_2 = \underline{1.41 \text{ MJ}}$$

c) With $K = 3,3$, the following equilibrium is valid:

$$K = \frac{n_{\text{CO}_2} \cdot n_{\text{H}_2}}{n_{\text{CO}} \cdot n_{\text{H}_2\text{O}}} = \frac{(18 + x)(40 + x)}{(40 - x)(200 - x)}$$

$$x_{1/2} = 184 \pm 151.6; x_1 = 33.2; x_2 = 336.4$$

The composition of the leaving gas is:

6.8 mol CO, 51.2 mol CO₂, 2.0 mol CH₄ and N₂, 73.2 mol H₂ and 166.8 mol H₂O.

IChO Paris 1990

a) The heat given off heats 1 mol of ZnS, 1.5 mol of O₂ and 6 mol of N₂. Therefore:

$$-\Delta_r H^\circ(1350) = \int_{298}^T [c_p(\text{ZnS}) + 1.5 c_p(\text{O}_2) + 6 c_p(\text{N}_2)] dT = 293.3(T - 298) = 448980 \text{ (J/mol)}$$

Thus $T \approx 1830 \text{ K}$, which indicates that the reaction is self-sustaining.

b) If n denotes the quantity (in moles) of SiO₂ per mol of ZnS, the heat given off heats 1 mol of ZnS, n mol of SiO₂, 1.5 mol of O₂ and 6 mol of N₂ from 298 to 1350 K:

$$-\Delta_r H^\circ = \int_{298}^{1350} \sum (n_i \cdot c_{p(i)}) dT = \int_{298}^{1305} (293.3 + 72.5n) dT$$

Therefrom: $448980 = (293.3 + 72.5n)(1350 - 298)$, so $n = 1.84 \text{ mol}$

c) By mass, we have 110.6 g of SiO₂ per 97.5 g of ZnS, or 46.9 g of ZnS per 100 g of mineral. The maximum tolerated ZnS content in the mineral is thus 46.9 %

IChO Paris 1990

a) In a buffer solution $[\text{H}_3\text{O}^+]$ is constant and the reaction of first order: $v = k' [\text{NO}_2\text{NH}_2]$

b) The rate laws of the three mechanisms proposed are:

$$v_1 = k_1 [\text{NO}_2\text{NH}_2]$$

$$v_2 = k_3 [\text{NO}_2\text{NH}_3^+] = k_3 k_2 / k_2 \cdot [\text{NO}_2\text{NH}_2] [\text{H}_3\text{O}^+]$$

$$v_3 = k_5 [\text{NO}_2\text{NH}^-] = k_5 k_4 / k_4 \cdot [\text{NO}_2\text{NH}_2] / [\text{H}_3\text{O}^+]$$

The third mechanism is correct.

c) $k = k_5 k_4 / k_4$.

d) Noting that $[\text{H}_3\text{O}^+] = K_e / [\text{OH}^-]$ it follows that $v = k / K_e [\text{NO}_2\text{NH}_2] [\text{OH}^-]$, which shows the catalytic role of OH⁻.

e) $d[\text{N}_2\text{O}]$ can be expressed by the change of pressure $dp_{\text{N}_2\text{O}}/RT$ (according to $pV = nRT$). We obtain:

$$v = \frac{d[\text{N}_2\text{O}]}{dt} = \frac{1}{RT} \frac{dp_{\text{N}_2\text{O}}}{dt} = \frac{1}{RT} \frac{dp}{dt} = k \frac{[\text{NO}_2\text{NH}_2]}{[\text{H}_3\text{O}^+]}$$

We also know that $V \cdot [\text{NO}_2\text{NH}_2] = n(\text{NO}_2\text{NH}_2)_0 - n(\text{N}_2\text{O}) = n(\text{N}_2\text{O})_\infty - n(\text{N}_2\text{O})$ from which

$$\frac{dp}{dt} = \frac{k}{[\text{H}_3\text{O}^+]} \cdot \frac{RT}{V} \cdot (n(\text{N}_2\text{O})_\infty - n(\text{N}_2\text{O}))$$

and thus

$$\frac{dp}{dt} = \frac{k}{[\text{H}_3\text{O}^+]} \cdot (p_\infty - p) = k'(p_\infty - p)$$

Integration gives $p = p_\infty (1 - e^{-k't})$ wherefrom: $e^{-k't} = 1 - p/p_\infty$

The graph of $f(x) = \ln(1 - p/p_\infty) = -k't$ is a straight line with the slope k' shown in Fig.13. k' was determined to be $3.7 \cdot 10^{-2} \text{ min}^{-1}$.

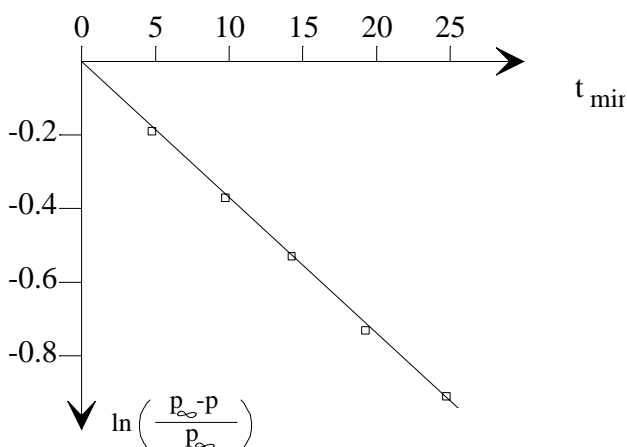

Fig. 13 Graph of $f(t)$

IChO Lodz 1991

a) $\Delta E_{n \rightarrow 1} = E_n - E_1 = 2.18 \cdot 10^{-18} (1 - n^{-2})$

$$\Delta E_{2 \rightarrow 1} = 1.635 \cdot 10^{-18} \text{ J}$$

$$\Delta E_{7 \rightarrow 1} = 2.135 \cdot 10^{-18} \text{ J}$$

b) The Lyman serie is due to $\Delta E_{n \rightarrow 1}$ varying from $1.635 \cdot 10^{-18} \text{ J}$ ($n = 1$) to $2.135 \cdot 10^{-18} \text{ J}$ ($n \rightarrow \infty$), which corresponds to 121.5 nm respectively to 93.0 nm. This is in the UV-region.

c) The ionisation energy is equal to $\Delta E_{\infty \rightarrow 1} = 2.18 \cdot 10^{-18} \text{ J}$. Both $\Delta E_{2 \rightarrow 1}$ and $\Delta E_{7 \rightarrow 1}$ are smaller than $\Delta E_{\infty \rightarrow 1}$ and a single photon emitted from these transitions is not able to ionize a hydrogen atom.

Ionization of copper in a Cu-crystal is related to the photoelectric effect:

$$h\nu = \Phi_{\text{Cu}} + E_{\text{kin}} = \Phi_{\text{Cu}} + \frac{1}{2} m_e v^2$$

Because $\Delta E_{2 \rightarrow 1} > \Phi_{\text{Cu}}$ and $\Delta E_{7 \rightarrow 1} > \Phi_{\text{Cu}}$ both photons are indeed able to ionize a Cu-atom in the crystal. The kinetic energy of the emitted electrons is:

$$\Delta E_{\text{kin}}(2 \rightarrow 1) = \Delta E_{2 \rightarrow 1} - \Phi_{\text{Cu}} = 8.91 \cdot 10^{-19} \text{ J}$$

$$\Delta E_{\text{kin}}(7 \rightarrow 1) = \Delta E_{7 \rightarrow 1} - \Phi_{\text{Cu}} = 13.91 \cdot 10^{-19} \text{ J}$$

d) The wavelength of an electron is: $\lambda = h/p = h/\sqrt{2E_{\text{kin}}m_e}$ (because $E_{\text{kin}} = p^2/(2m_e)$)

$$\lambda_1 = 4.16 \cdot 10^{-10} \text{ m} = 4.16 \text{ \AA}$$

$$\lambda_2 = 5.20 \cdot 10^{-10} \text{ m} = 5.20 \text{ \AA}$$

IChO Pittsburgh 1992

a) The structure of NO_2 is:

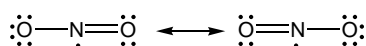

b) The structure of N_2O_4 is

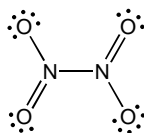

(At very low temperatures there is another structure of N_2O_4 possible: $\text{O}=\text{N}-\text{ONO}_2$, nitrosyl nitrate)

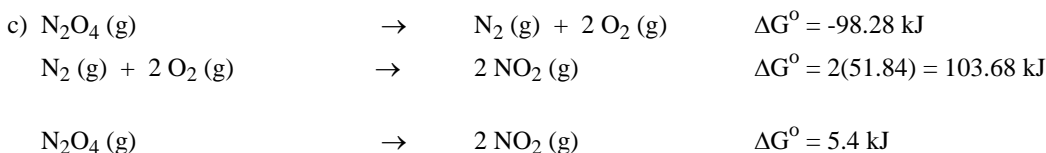

If x denotes the fraction of decomposed N_2O_4 and P_T the partial pressure and X the mole fraction of the corresponding species, we obtain:

$$K_p = 0.113 = \frac{(P_{\text{NO}_2})^2}{P_{\text{N}_2\text{O}_4}} = \frac{(P_T X_{\text{NO}_2})^2}{P_T X_{\text{N}_2\text{O}_4}} = \frac{\left(\frac{2x}{1+x}\right)^2}{\frac{1-x}{1+x}} = \frac{4x^2}{1-x^2}$$

wherefrom $x = 0.166$

d) If $2 \cdot 0.166 = 0.332$ atm of N_2O_4 decomposes, 0.664 atm of NO_2 forms, thus

$$K_p = \frac{(0.664^2 / 1.332)}{(1 - 0.332) / (1 + 0.332)} = 0.496$$

From the $\Delta G = -RT \ln K$ and $\Delta G = \Delta H - T\Delta S$ we obtain $\ln K = -\Delta H / (RT) + \Delta S/R$. Supposing that ΔH and ΔS are constants, $\ln K$ is inverse proportional to T and we can put $d(\ln K)/d(1/T) = -\Delta H/R$. Since $d(1/T) = -dT/(T^2)$ we obtain the equation of van't Hoff:

$$\frac{d(\ln k)}{dT} = \frac{\Delta H_o}{RT^2}$$

which yields

$$\ln \frac{K_2}{K_1} = -\frac{\Delta H_o}{R} \cdot \left(\frac{1}{T_2} - \frac{1}{T_1} \right)$$

upon integrating in the temperature range $[T_1, T_2]$. As a result we obtain $T_2 = 318 \text{ K}$.

- e) The first-order rate law is: $A(t) = A_o \cdot e^{-kt}$ and thus $t = \ln 0.8 / (-5.3 \cdot 10^4) = 4.2 \cdot 10^{-6} \text{ s}$
 f) $K = k_1/k_2 = (9.8 \cdot 10^6)/(5.3 \cdot 10^4) = 1.8 \cdot 10^2$

IChO Pittsburgh 1992

- a) $[\text{CO}_2(\text{aq})] = K_H P_{\text{CO}_2} = 0.0343 \text{ M/atm} \cdot 440 \cdot 10^{-6} \text{ atm} = 1.51 \cdot 10^{-5} \text{ M}$
 $\text{CO}_2(\text{aq}) + \text{H}_2\text{O}(\text{l}) \rightleftharpoons \text{H}^+(\text{aq}) + \text{HCO}_3^-(\text{aq}) \quad \Delta G^\circ = 36.3 \text{ kJ/mol}; K = e^{-\Delta G/RT} = 4.37 \cdot 10^{-7}$
 $K = [\text{H}^+][\text{HCO}_3^-]/[\text{CO}_2] = x^2/[\text{CO}_2]$ since $x = [\text{H}^+] = [\text{HCO}_3^-]$.
 Solving for x yields $[\text{H}^+] = 2.57 \cdot 10^{-6}$; $\text{pH} = 5.59$
- b) $\Delta H^\circ = \Delta H^\circ_f(\text{HCO}_3^-) - \Delta H^\circ_f(\text{CO}_2) - \Delta H^\circ_f(\text{H}_2\text{O}) = -691.2 - (-412.9) - (-285.8) = 7.5 \text{ kJ/mol}$
 c) Since the reaction is endothermic, the equilibrium constant will increase with temperature. Therefore $[\text{H}^+]$ will also increase and the pH will decrease.

IChO Peruggia 1993

- a) $\Delta_I H^\circ = 74.9 - 393.5 - 2 \cdot 241.8 = -802.2 \text{ kJ mol}^{-1}$
 $\Delta_I S^\circ = -186.2 - 2 \cdot 205.0 + 213.6 + 2 \cdot 188.7 = -5.2 \text{ JK}^{-1}\text{mol}^{-1}$
 $K_I = \exp [-(\Delta_I H^\circ - \Delta_I S^\circ)/RT] = \exp[(802.2 - 1.5 \cdot 5.2)/8.314 \cdot 1.5] = 4.62 \cdot 10^{27}$
 $\Delta_{II} H^\circ = 74.9 - 110.5 - 2 \cdot 241.8 = -519.2 \text{ kJ mol}^{-1}$
 $\Delta_{II} S^\circ = -186.2 - 2 \cdot 205.0 + 197.6 + 2 \cdot 188.7 = 81.3 \text{ JK}^{-1}\text{mol}^{-1}$
 $K_{II} = \exp [-(\Delta_{II} H^\circ - \Delta_{II} S^\circ)/RT] = \exp[(519.2 - 1.5 \cdot 81.3)/8.314 \cdot 1.5] = 2.13 \cdot 10^{22}$
- b) Since K_I and K_{II} are very large, both equilibria are completely shifted to the right, so that $n_{\text{CH}_4} = 0$.
 At equilibrium we have the following concentrations:
 $n_{\text{CH}_4} = 0$; $n_{\text{H}_2\text{O}} = 2$; $n_{\text{N}_2} = 8$; $n_{\text{CO}_2} + n_{\text{CO}} = 1$; $n_{\text{O}_2} = 2 - (2n_{\text{CO}_2} + 1.5 n_{\text{CO}}) = 0.5 n_{\text{CO}}$
- c) In the reaction I the total number of moles does not vary; however it changes in II from 8.5 to 9.
 Before the reaction we have $n_{\text{tot}} = n_{\text{CH}_4} + n_{\text{O}_2} + n_{\text{N}_2} = 1 + 2 + 8 = 11$
 $K_{II}/K_I = P_{\text{CO}} P_{\text{O}_2}^{1/2} P_{\text{CO}_2} = x_{\text{CO}} (x_{\text{O}_2} P)^{1/2} / x_{\text{CO}_2}$
 $x_{\text{CO}_2} = n_{\text{CO}_2} / n_{\text{tot}} = (1 - n_{\text{CO}}) / n_{\text{tot}} = 1/11$ since $n_{\text{CO}} \ll n_{\text{CO}_2}$ as a consequence of $K_{II} \ll K_I$
 $(x_{\text{CO}})^{3/2} = (K_{II}/K_I)(2/P)^{1/2} / 11 = (2.13 \cdot 10^{22} \cdot 1.414) / (4.62 \cdot 10^{27} \cdot 11) = 5.93 \cdot 10^{-7}$.
 $x_{\text{CO}} = 7.06 \cdot 10^{-5}$

$$d) n_{\text{tot}} = n_{\text{CH}_4} + n_{\text{O}_2} + n_{\text{N}_2} = 1 + 4 + 16 = 21$$

$$\text{At equilibrium: } n_{\text{O}_2} = 4 - (2n_{\text{CO}_2} + 1.5n_{\text{CO}}) = 2 + 0.5n_{\text{CO}} = 2$$

$$n_{\text{CO}_2} = 1 - n_{\text{CO}}$$

$$K_{\text{II}}/K_{\text{I}} = P_{\text{CO}}P_{\text{O}_2}^{1/2}P_{\text{CO}_2} = x_{\text{CO}}(x_{\text{O}_2}P)^{1/2}/x_{\text{CO}_2} = x_{\text{CO}}(2/21)^{1/2} \cdot 21 = 42^{1/2} x_{\text{CO}}$$

$$x_{\text{CO}} = 42^{-1/2} K_{\text{II}}/K_{\text{I}} = 42^{-1/2} \cdot 2.13 \cdot 10^{22}/4.62 \cdot 10^{27} = 7.11 \cdot 10^{-7}$$

e) As a consequence of the condensation of water vapour, the number of moles in the gaseous phase changes from 11 to 9 in case c) and from 21 to 19 in case d). Therefore, the mole fraction of CO changes, too.

$$x_{\text{CO}} = 7.06 \cdot 10^{-5} \cdot 11/9 = 8.63 \cdot 10^{-5} \text{ in case c)}$$

$$x_{\text{CO}} = 7.11 \cdot 10^{-7} \cdot 21/19 = 7.86 \cdot 10^{-7} \text{ in case d)}$$

These two values correspond to 86 ppm and 0.8 ppm, respectively.

4. Technical Chemistry

IChO Leiden 1986

a) In order to minimize the pieces of apparatus, the liquids A and B should evaporate together. For complete consumption of the starting materials, A and B are recirculated as feed for the reactor. The scheme of figure 14 depicts two possible solutions.

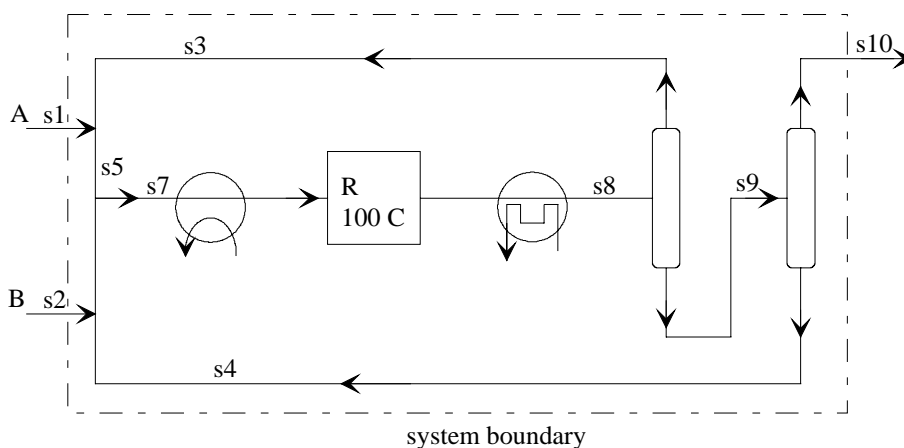
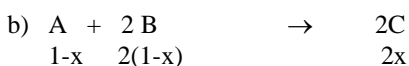

Fig. 14 Possible flow sheet of the process



In total $3-x$ mol gases are present after conversion. Supposing that the input of A is a mol (S5) and the input of B b mol (S6) we can write for the equilibrium:

$$K_p = \frac{P_c^2}{P_A \cdot P_B^2} = 10.0 \text{ M / Pa}$$

If x mol of A are converted, S8 contains $(a-x)$ mol of A, $(b-2x)$ mol of B and $2x$ mol of C. Therefore S8 contains $(a-x) + (b-2x) + 2x = (a+b-x)$ moles and we can write for the partial pressures of A and B:

$$p_A = \frac{a - x}{a + b - x} \cdot P \quad p_B = \frac{b - 2x}{a + b - x} \cdot P \quad p_C = \frac{2x}{a + b - x}$$

Therefore the equilibrium can be written as

$$K_p = \frac{(2x)^2}{(a - x) \cdot (b - 2x)^2} \cdot \frac{a + b - x}{P} = 10$$

- c) For $P = 0.10$ we obtain: $4x^2a + 4x^2b - 4x^3 = ab^2 - 4abx + 4ax^2 - xb^2 + 4x^2b - 4x^3$ and therefrom

$$0 = ab^2 - 4abx - xb^2 \text{ and since } b \neq 0: 0 = ab - 4ax - bx$$

With a total inflow of 0.5 mol/s A (S1) and 1 mol/s B (S2), the amount of C leaving the reactor (S10) is 1 mol/s. So $2x = 1$ and $x = 0.5$. The relation between a and b can be written as: $a = b/(2b - 4)$. Since the feed is stoichiometric $a:b = 1:2$. This leads to $b = 3$ and $a = 1.5$.

All flows (mol/s) can be calculated now:

$$S1 = 0.5 \text{ mol/s A}$$

$$S2 = 1 \text{ mol/s B}$$

$$S3 = 1.5 - 0.5 = 1 \text{ mol/s A}$$

$$S4 = 3 - 1 = 2 \text{ mol/s A}$$

$$S5 = a = 1.5 \text{ mol/s A}$$

$$S6 = b = 3 \text{ mol/s B}$$

$$S7 = 1.5 \text{ mol/s A} + 3 \text{ mol/s B}$$

$$S8 = 1 \text{ mol/s A} + 2 \text{ mol/s B} + 1 \text{ mol/s C}$$

$$S10 = 1 \text{ mol C}$$

$$S9_1 = 2 \text{ mol B} + 1 \text{ mol C}; S9_2 = 1 \text{ mol A} + 1 \text{ mol C}$$

- d) By increasing the pressure, the equilibrium is pushed towards the side with the smallest number of molecules, that means to the right side. Another possibility is changing the ratio of the feed, i.e. a:B. According to $a = b/(2b-4)$, b will be larger if a decreases and vice versa. Because the net enthalpy change is 0, temperature has no effect.
- e) Energy must be supplied for heating the evaporator and for the two distillation columns. The total energy consumed of the flow in scheme can be calculated as follows:

$$Q1 = q \cdot S7 + 3q \cdot S3 + 3q \cdot S10 = 10.5 q$$

IChO Veszprém - Budapest 1987

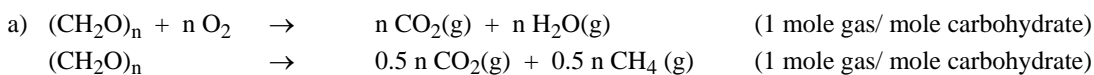

For 16 m^3 of gases : $n_{\text{gas}} = pV/(RT) = 646 \text{ mole}$ (55%) with the rest (45%) therefore being sludge.

The amount of sludge is $45/55 \cdot 646 = 528 \text{ mole}$, that is 15.85 kg/day.

b) $n(\text{CH}_4) = 5/55 \cdot 646 = 58.71 \text{ mole}$

$$\Delta H = -882 \cdot 58.71 = \underline{-5.178 \cdot 10^4 \text{ kJ/day}}$$

- c) The sum of CH_2O is $646 / 0.55 = 1174 \text{ mole}$. Since $250 \text{ mg/dm}^3 = 0.25 \text{ kg/m}^3$ the daily amount of water is: $v = (1174 \cdot 30) / (10^3 \cdot 0.25) = \underline{140.9 \text{ m}^3/\text{day}}$

IChO Halle 1989

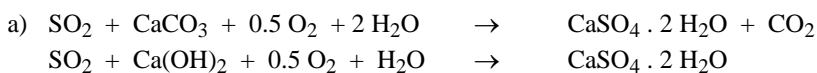

b) Under given conditions:

$$n(\text{SO}_2/\text{h}) = v(\text{SO}_2/\text{h}) / V = 669.34 \text{ mol/h}$$

$$M(\text{CaCO}_3/\text{d}) = n(\text{SO}_2/\text{h}) \cdot M(\text{CaCO}_3) \cdot 24 \text{ h} \cdot \text{d}^{-1} \cdot 0.95 = \underline{1.53 \cdot 10^3 \text{ kg/d}}$$

c) $m(\text{CaSO}_4 \cdot 2\text{H}_2\text{O}) = (M(\text{CaSO}_4 \cdot 2\text{H}_2\text{O})/M(\text{CaCO}_3)) \cdot m(\text{CaCO}_3/\text{d}) = \underline{2.63 \cdot 10^3 \text{ kg/d}}$

d) $\text{pH} = -\log[\text{H}_3\text{O}^+]$; $K_a = [\text{H}_3\text{O}^+]^2 / ([\text{SO}_2] - [\text{H}_3\text{O}^+])$

Solving for $[\text{H}_3\text{O}^+]$ yields to:

$$[\text{H}_3\text{O}^+]_{1/2} = -\frac{K_a}{2} \pm \sqrt{\frac{K_a^2}{4} + K_a \cdot [\text{SO}_2]}$$

with $[\text{SO}_2] = n(\text{SO}_2)/V = 1.34 \cdot 10^{-4} \text{ mol/l}$ and $K_a = 10^{-2.25} \text{ mol/l}$, $[\text{H}_3\text{O}^+] = 1.32 \cdot 10^{-4} \text{ mol/l}$ and $\text{pH} = \underline{3.88}$

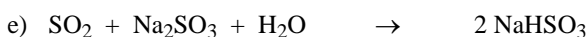

Possibilities to increase the recovery of SO_2 are: temperature rise, reduced pressure, lower pH-value.

IChO Paris 1990

a) In the continuous stirred reactor, concentrations are time independent and identical at every point. This means that the differential yield y for a given p is identical to the mean yield Y . A maximum mean yield is therefore obtained for y_{max} . From the graph it's seen that $y_{\text{max}} = 0.99$ with $p = 0.95$.

b) In a continuous plug flow reactor concentrations are time-independent but dependent upon the location in the reactor. We shall consider a thin slice dx of the reactor at the entrance and at the end of the reactor. At the entrance $[\text{C}_6\text{H}_6] = 1$ and $[\text{C}_6\text{H}_{12}] = 0$, thus $p=0$ and $y=0.97$. At the outlet of the reactor we have: $[\text{C}_6\text{H}_6] = 0$ and $[\text{C}_6\text{H}_{12}] = 1$. So, $p = 1$ and $y = 0.985$. The mean yield is now the average of y over all p , which is 0.98 as one can easily see from the graph given.

c) In the plug flow reactor, the quantity of benzene lost (not hydrogenated) is $1-p$. Fig. 15 shows the area that represents the amount of benzene that is not hydrogenated and therefore lost. For the installation MP we first have the amount of benzene lost in the continuous stirred reactor which is always $1 - 0.99 = 0.01$ independent from p up to a point $p = 0.95$. At $p > 0.95$ to the continuous plug reactor has the same loss of benzene as already indicated in the Fig. 14 above.

d) In the plug reactor the percentage of benzene lost is 2% (the best mean yield is 0.98), therefore the amount benzene annually lost is 2000 tons/year.

In a MP installation, the yield of hydrogenation is 0.99 (except for $0.95 < p < 1$ where it slightly decreases to 0.985, but this can be neglected) and therefore the overall mean yield of hydrogenation is also 0.99.

The amount of benzene annually lost is 1000 tons/year.

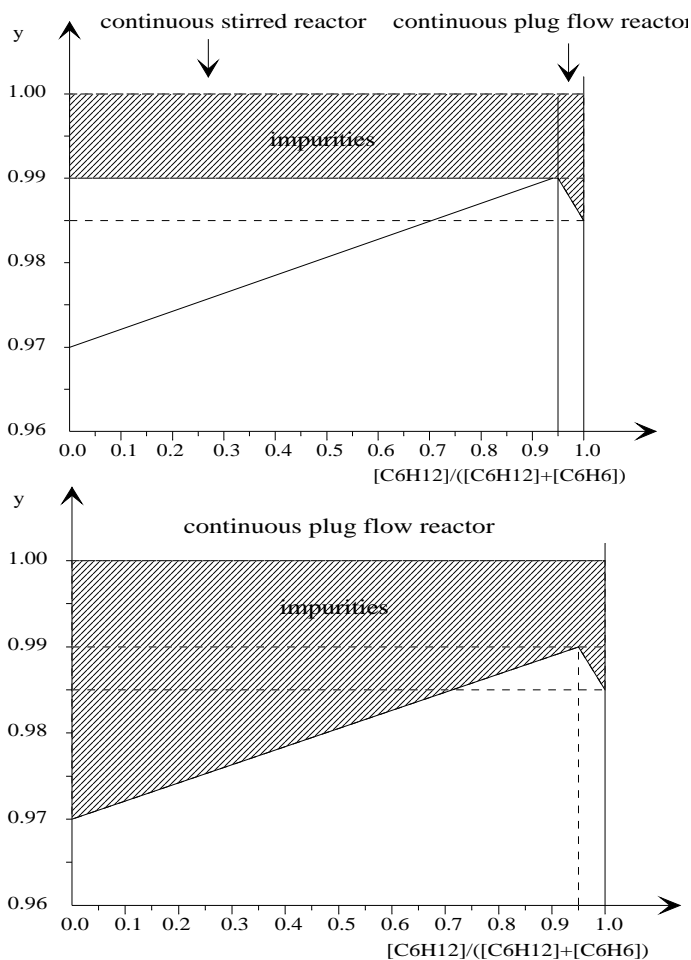

Fig. 14 Amount of benzene lost in the P and MP reactor

5. Organic chemistry

IChO Leiden 1986

a) The high rate of hydrolysis of A is caused by intramolecular catalysis of the COOH group in the cis-position. In B the COOH group is situated in the trans-position with respect to the amide group and therefore too far away for intramolecular catalysis.

b) For $0 < \text{pH} < 2$ the COOH group is not ionized and it can therefore act as an intramolecular catalyzer. If the hydrolysis in that pH-range is only the result of catalysis by the COOH-group and not competing with H_3O^+ the rate constant in that range is pH independent.

c) At $\text{pH} > 3$ the COOH-group deprotonates giving COO^- . Intramolecular acid catalysis in which proton transfer plays an important role is then not possible anymore.

d) The mechanism of hydrolysis is indicated below:

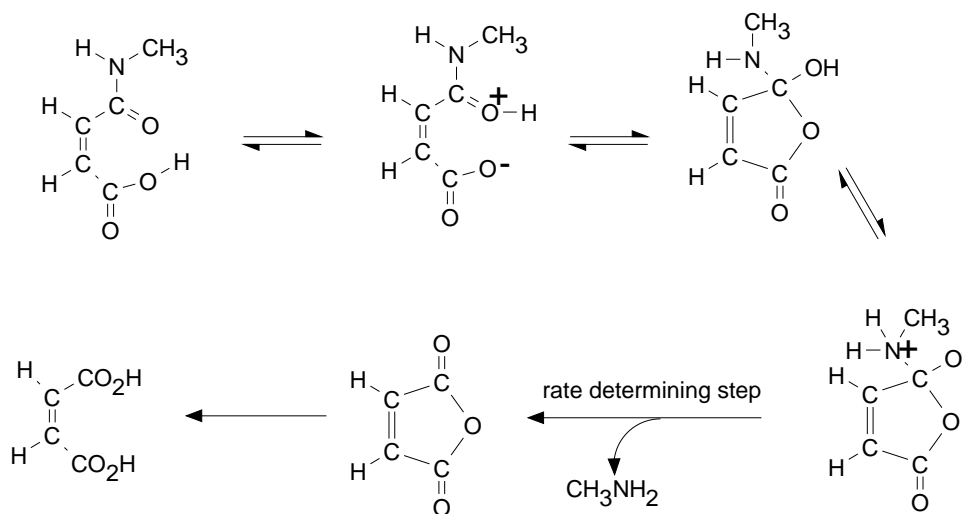

e)

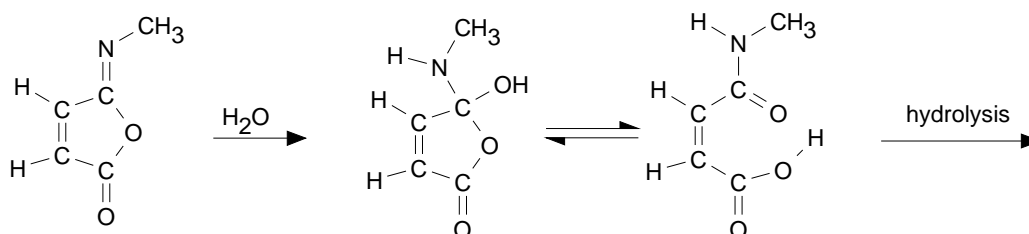

With the observation given, the rate determining step can be identified.

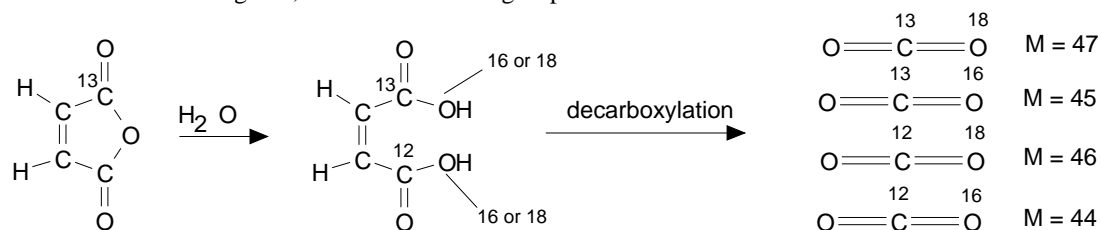

IChO Leiden 1986

a)

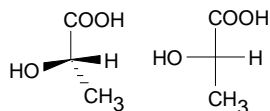
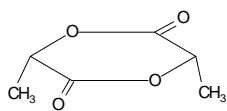
L-(+)-lactic acid and
its Fischer projectionDilactide of L-(+)-lactic acid
spatial formula

b)

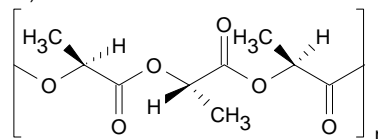

Polylactide of L-(+)-lactic acid

c) Dilactides of racemic lactic acid with the following configurations:

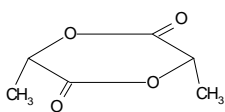

(R,R)

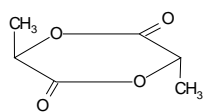

(S,S)

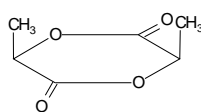

(R,S) meso compound

d)

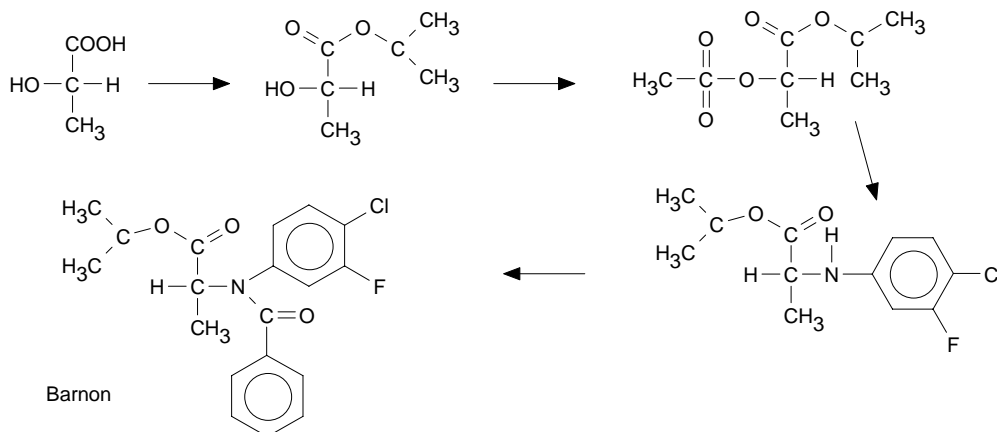
**IChO Veszprém - Budapest 1987**

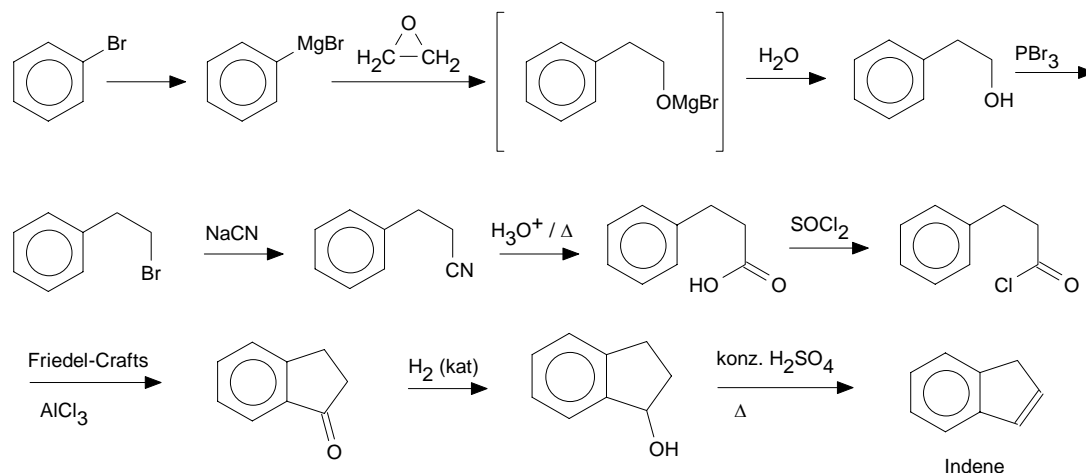

IChO Veszprém - Budapest 1987

- a) The ratio of primary / secondary and tertiary products will be 9:2:1.
- b) 1-pentanol reacts with a) cold conc. sulphuric acid (elimination) and with b) $\text{CrO}_3/\text{H}_2\text{SO}_4$ (oxidation)
 2-pentanol reacts with a) under elimination, with b) under oxidation, with c) under reduction and with d) (Haloform oxidation)
 2-methyl-2-butanol reacts with a) under elimination and with c) under reduction
- c) a/c and b/d are enantiomers, a/b, a/d, b/c and c/d are diastereomers.
- d) The compounds are 2-cis-butene and 2-trans-butene
- e) glycerol, choline, phosphoric acid and fatty acids can be found during complete hydrolysis of lecithin.
- f) malic acid, oxalacetic acid, ketoglutaric acid, fumaric acid
- g) c) is correct since the NAD^+ is converted into NADH/H^+

IChO Halle 1989

- a) constitutional isomers:

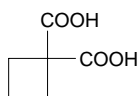

1,1 - cyclobutane - dicarboxylic acid

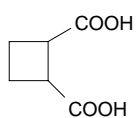

1,2 - cyclobutane - dicarboxylic acid

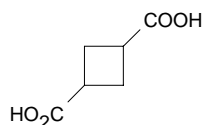

1,3 - cyclobutane - dicarboxylic acid

- b) stereoisomers

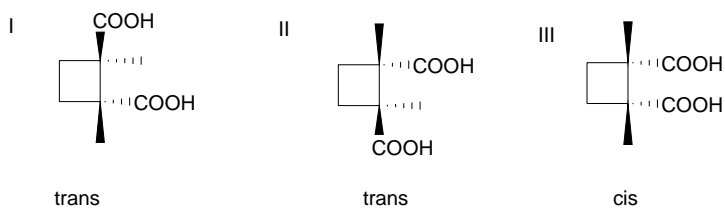

c) Diastereomers are I, III and II, III; enantiomeric pairs are I and II.

d) On losing water the cis-diastereomer forms the corresponding anhydride according to:

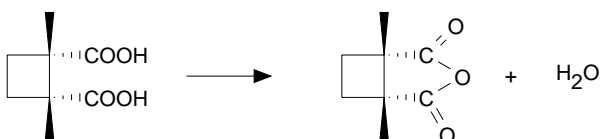

e) The trans-diastereomer can be precipitated with an optically active base.

f)	stereoisomers	absolute configuration
	I	R,R
	II	S,S
	III	R,S

g)

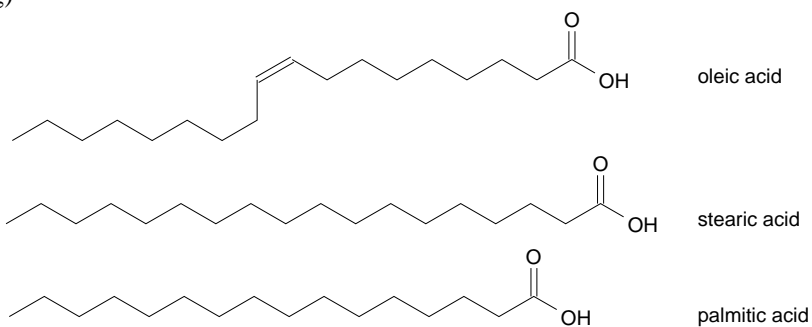

a possible structure of a triacyl glyceride with the fatty acids mentioned is:

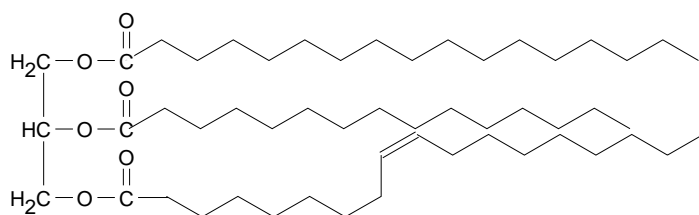

h)

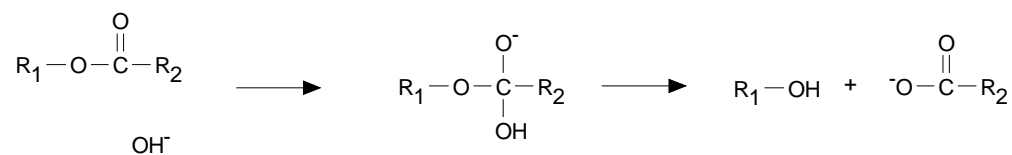
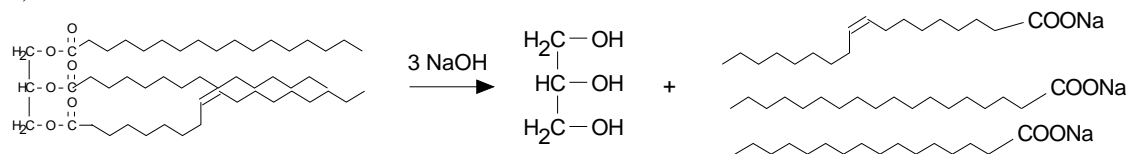
i) It's $\text{C}_{21}\text{H}_{43}\text{COOH}$

k) an example for a phospholipid is:

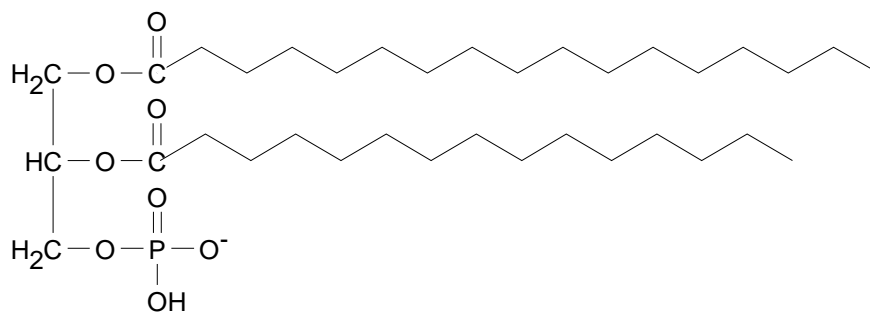

l) six molecules of phospholipids can form the following possibilities for association:

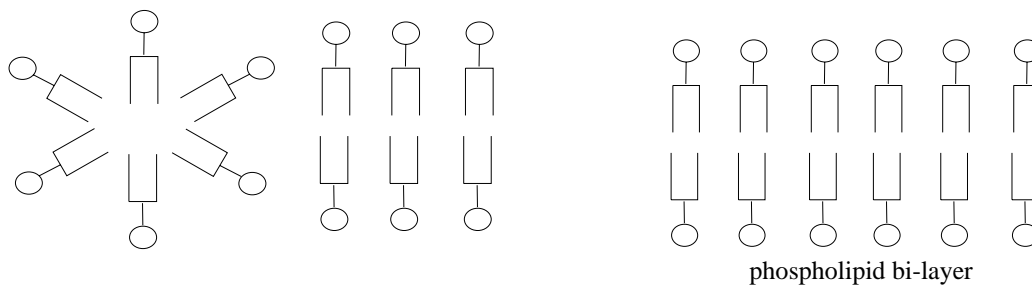

phospholipid bi-layer

i) The structure of a phospholipid bi-layer is shown above. Protein (enzymes) also contain such layers.

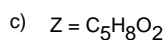
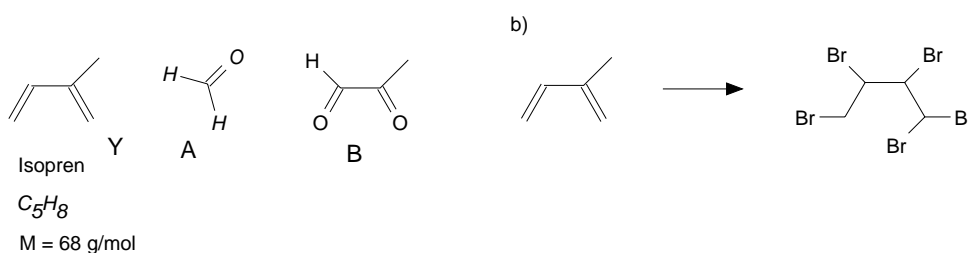
IChO Lodz 1991

There's one double bond per monomer unit.

- d) The molar mass of C is 116 g/mol. Z must be a keto aldehyde since there is an aldehyde function and a methyl group next to the carbonyl-group (haloform-reaction).

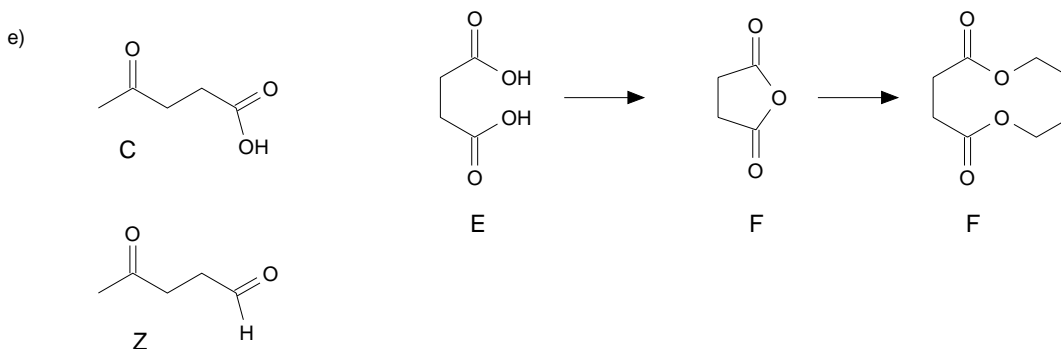

- f) There are two isomeric form (all cis or all trans) possible:

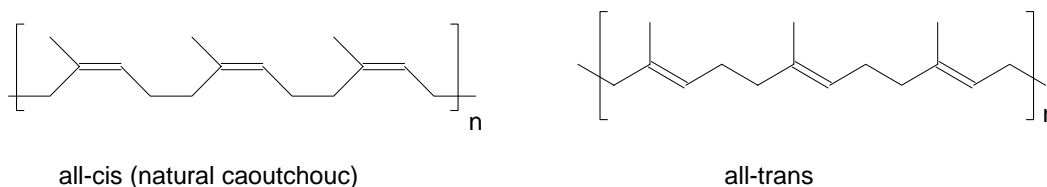
**IChO Lodz 1991**

- a) A - benzene F - 2,2',5,5' - tetrachlorobiphenyl
 B - biphenyl G₁ - 2,2', 5,5' - pentachlorobiphenyl
 C - 2-chlorobiphenyl G₂ - 2,2', 3,5,5' - pentachlorobiphenyl
 D - 2,2' - dichlorobiphenyl G₃ - 2,2', 3,5',6 - pentachlorobiphenyl
 E - 2,2', 5 - trichlorobiphenyl

For the determination of the halogen of E we consider the ratio of the isotopic peaks in the mass spectrum.

For E (n=3) we have: $(x+y)^3 = x^3 + 3x^2y + 3xy^2 + y^3$.

Therefore, with Br we obtain: $x:y = 50.54:49.46 \approx 1:1$ hence $(x+y)^3 = 1 + 3 + 3 + 1$ and the ratio would be 1:3:3:1 which is not in agreement with the text. For chlorine the isotopic ratio is $75.53:24.47 \approx 1:3$ and

therefore $(x+y)^3 = 3^3 + 3 \cdot 3^2 \cdot 1 + 3 \cdot 3 \cdot 1^2$, which yields to a ratio of 1:1:0.33:0.04. So, the X-atom is chlorine.

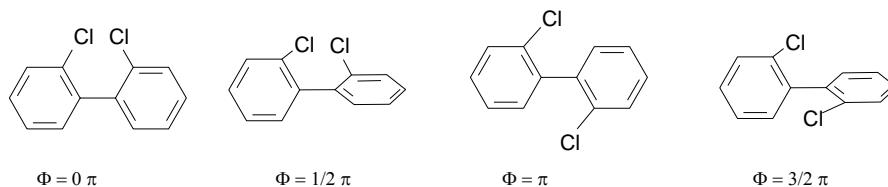

c)

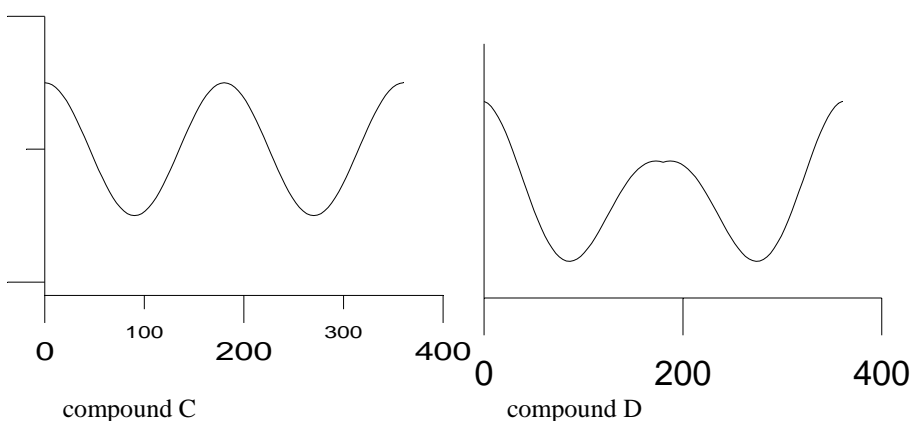

d) Due to the increasing steric hindrance as a result of the interference of the big Van der Waals radii of chlorine, the rotation around the C-C single bond becomes more and more difficult. Therefore racemization is most likely to occur with G1, less with G2 and least with G3. This kind of isomerism is called atropisomerism:

e)

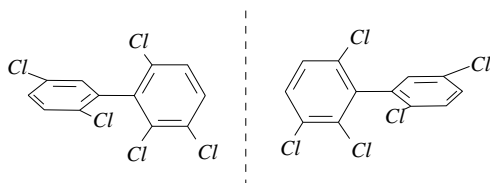

- f)
- Complete combustion in chemical incinerator equipped with an afterburner and scrubber
 - Addition of a strong base to obtain corresponding phenols
 - Transformation into ArOH by OH-radicals in water
 - Bacteria metabolizing polychlorobiphenyls

IChO Paris 1990

a)

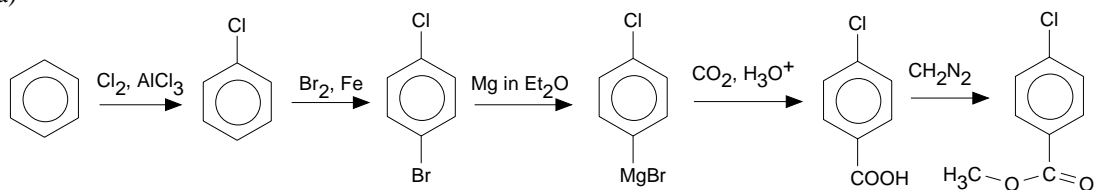

b)

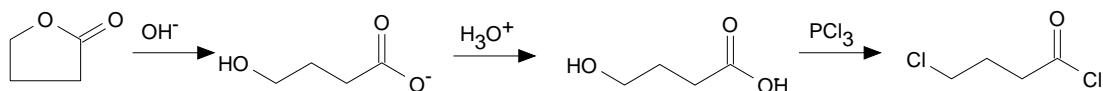

c)

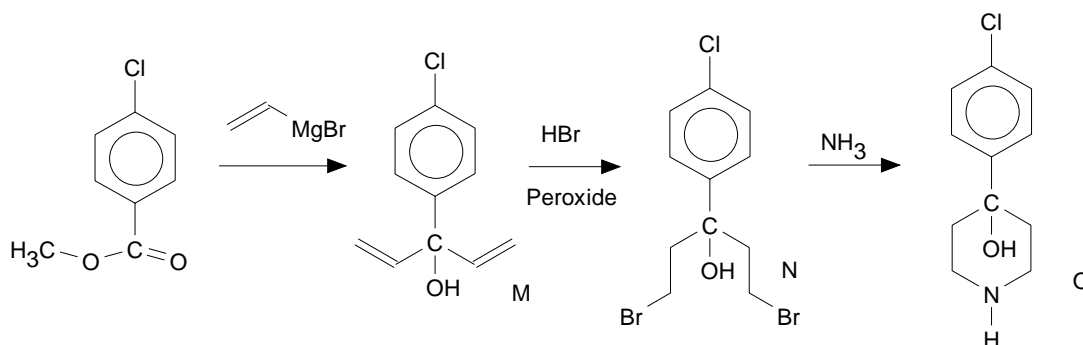

mechanism of the Grignard reaction:

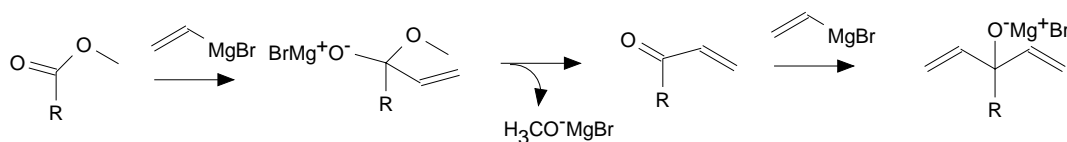

d)

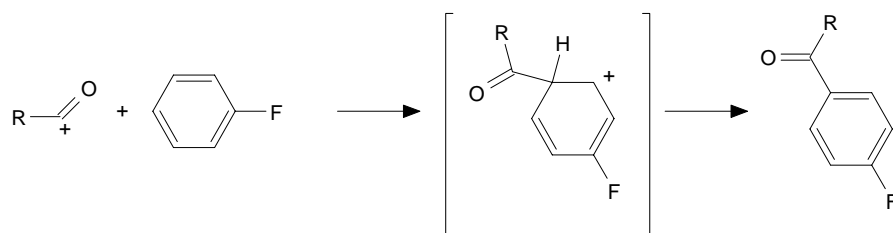
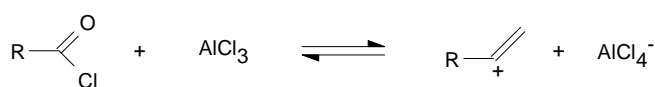
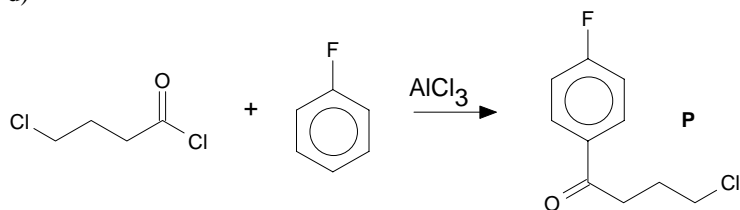

e) chemical test: carbonyl groups react with phenylhydrazines to phenylhydrazones with a sharp, specific melting point

physical test: IR-absorption at 1740 cm^{-1}

A possibility to distinguish between ketones and aldehydes is the Tollens-test (silver mirror), ketones can't be reduced whereas aldehydes easily oxidize the silver ions to elementary silver.

f)

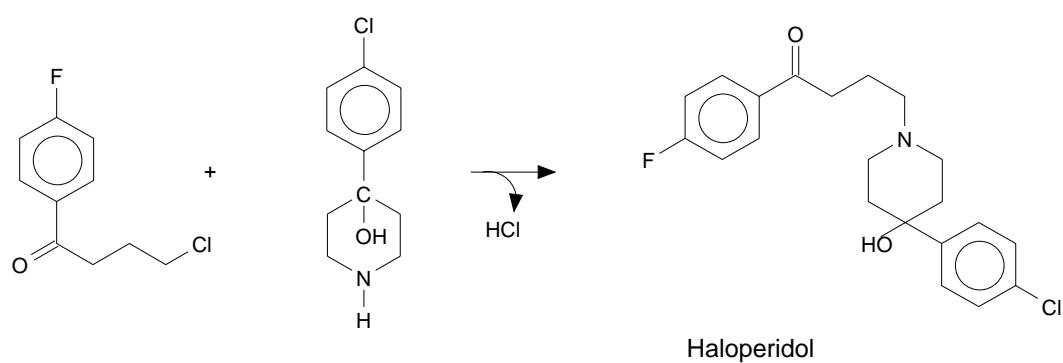

g)

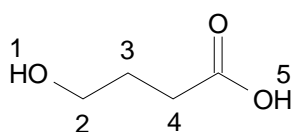

proton 1: singlet
proton 2: triplet
proton 3: quintuplet
proton 4: triplet
proton 5: singlet

IChO Pittsburgh 1992

a) Structures of compounds A-F

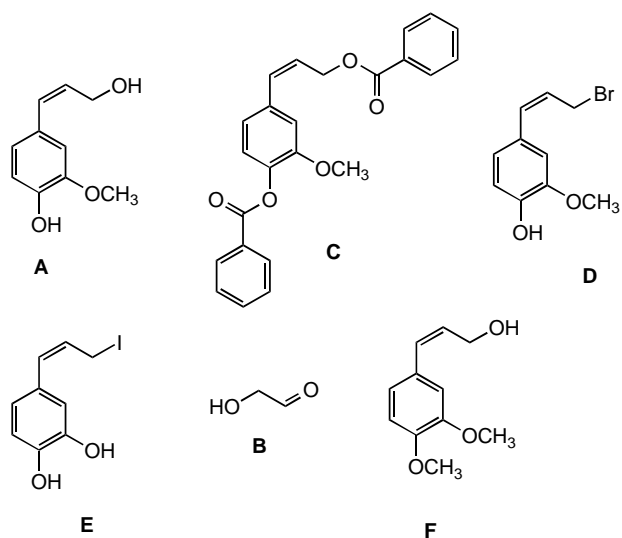

b) There are no geometric isomers, but 2 pairs of enantiomers (diastereomers). The structure and the Fischer projection is shown below.

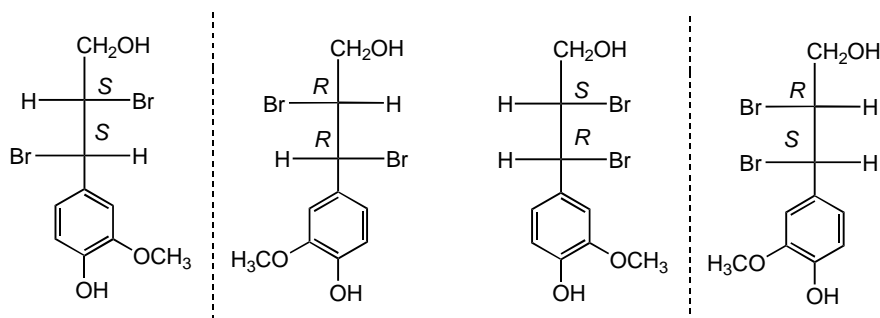
**IChO Pittsburgh 1992**

a)

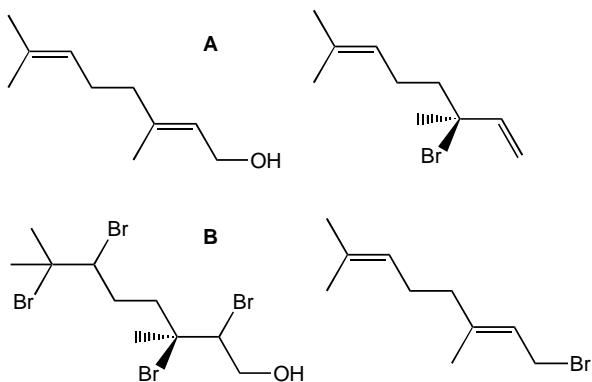

b) There are two possible carbocations that may form upon elimination of water and rearrangement. Since the tertiary carbocation is more stable than the primary carbocation the greatest proportion of the bromide would be the tertiary bromide:

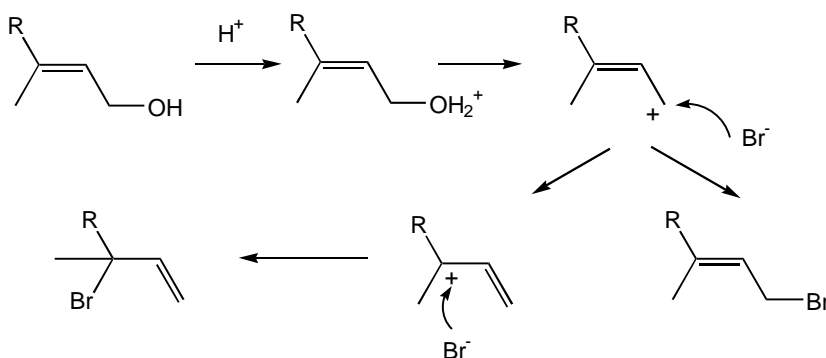
**IChO Pittsburgh 1991**

The products of the reactions are listed below:

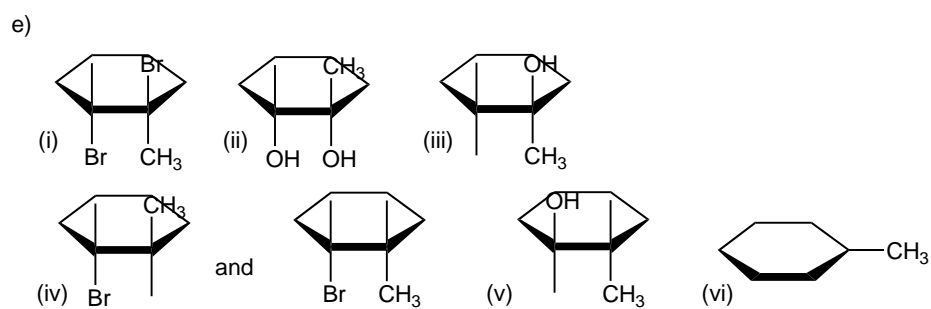
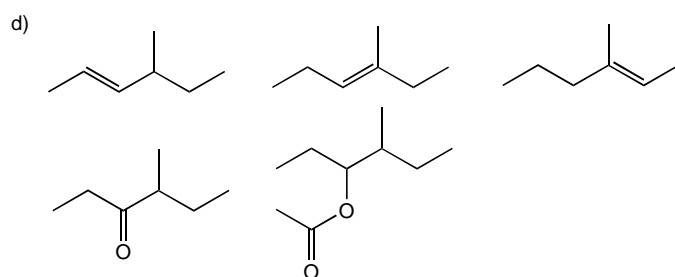
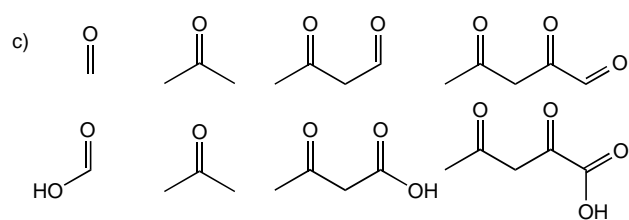
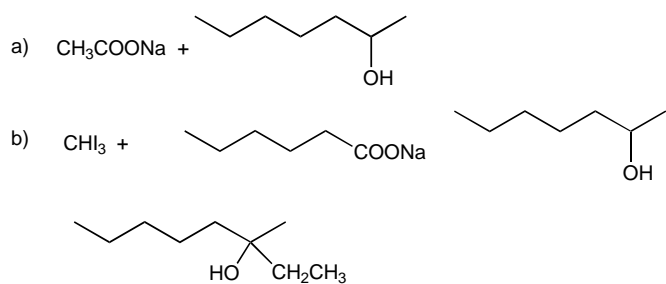

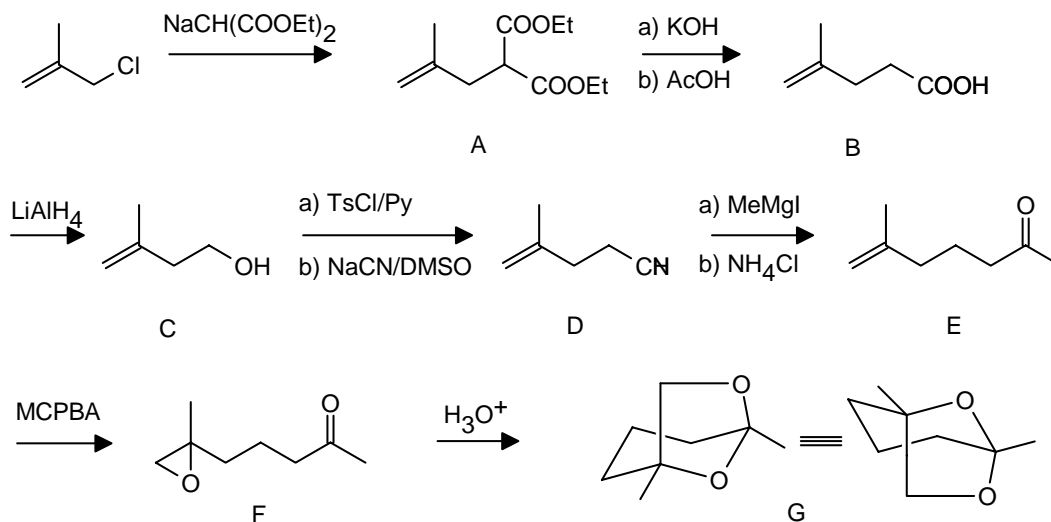
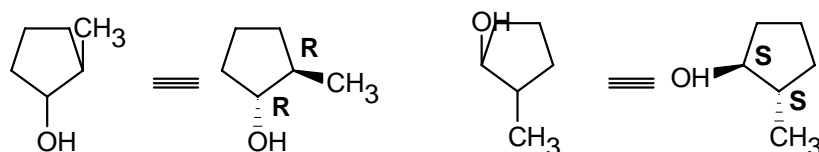
IChO Perugia 93**IChO Perugia 93**

c) Due to the chirality of the hydroborating agent, one enantiomer prevails against the other.

6. Biochemistry**IChO Leiden 1986**

- 5' - pTpApGpCpT ↓pC
- The probability of the sequence given is $(1/4)^6 = 1/4096$. Thus, this specific sequence may occur in the DNA $10^5/4096 = 24.4$ times on average.
- The sequence recognized by Taq I is 2 base pairs, that is 4 bases.
- The sequence is 5' - pTpCpGpA - 3' or 5' - pGpApTpC - 3'
-

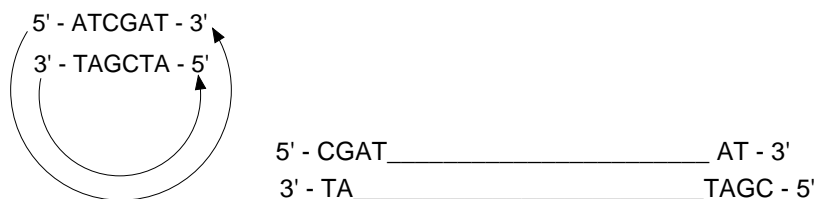

- f) The reaction has a positive enthalpy, since the hydrogen bonds between the bases G and C in the complementary strands are broken.
- g) The two relations show the same dependence on temperature. Therefore, the enthalpy of the two reactions is roughly the same. Then the interaction of the double helix must be identical and therefore we must choose TCGA for the first recognition sequence of question d). The cleavage in the two cases mentioned in d) occurs as follows:

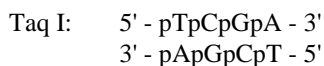
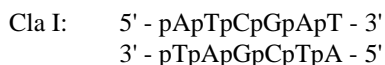

- h) The following curve would be obtained

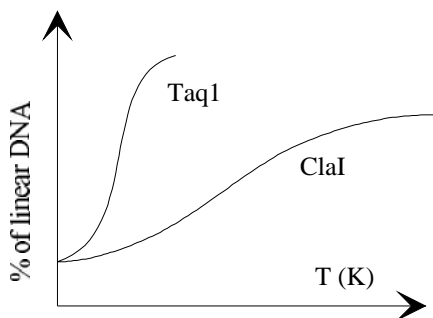

- l) ΔH is negative.
- k) Low temperature, low DNA concentration and high ionic strength will give the maximum percentage of recombinant molecules.

ICHO Paris 1990

- a) There are four isomers. The catalytic deuteration is a syn deuteration

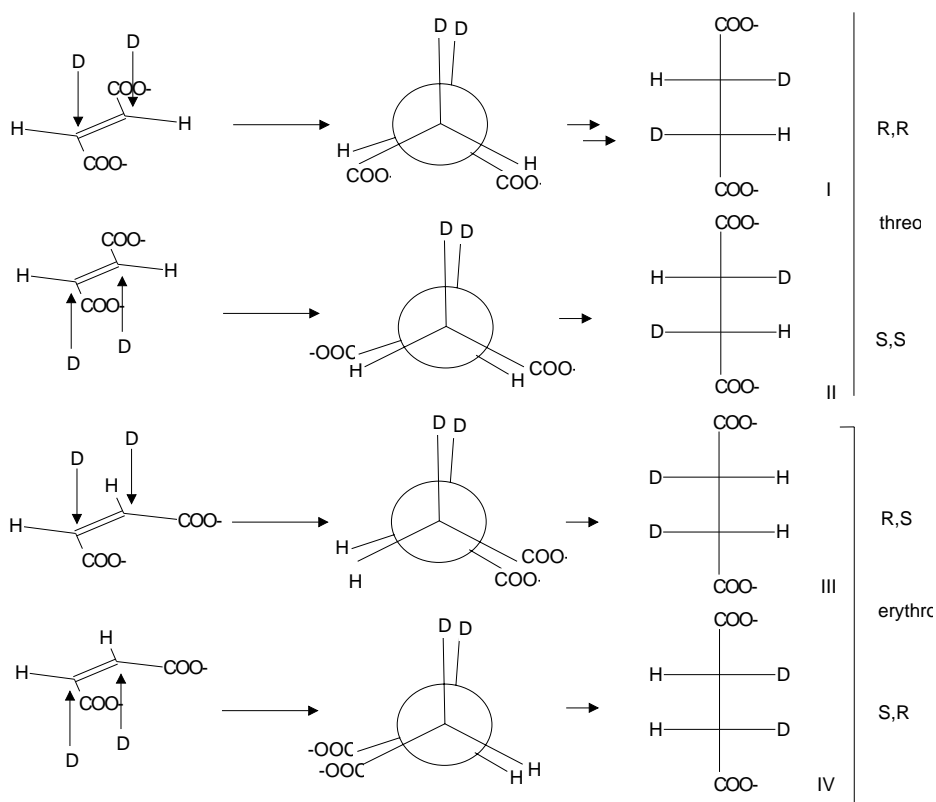

The most stable conformation for succinates is the anti form, since the distance between the bulky COO^- groups is maximal:

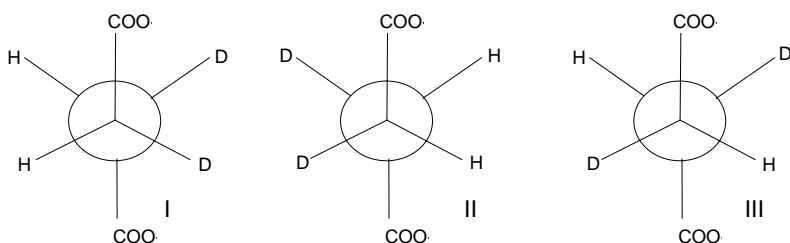

I and II are enantiomers, II and III are a meso isomere, thus there are in total three isomers (two enantiomers and one meso form). Each threo and the meso form are diastereomers.

b) Considering the Newman projections of the three isomers it is clear that syn elimination of I and II leads either to fumarate containing no D or to dideuterated fumarate (percentage of dideuterated fumarate is thus 50%) whereas anti elimination leads to monodeuterated fumarate. Concerning the experiment 4% of dideuterated fumarate indicates that anti elimination occurs. Syn - elimination of the meso-form only leads to monodeuterated fumarate, whereas anti-elimination gives 50% normal and 50% dideuterated fumarate. This is in accordance with the experiment where 48.5% of dideuterated fumarate are obtained after enzymatic dehydrogenation of the meso isomer formed from maleic acid.

d) The enzymatic dehydrogenation is a anti elimination as shown above.